

STEM Electronics

Bauanleitung
Assembly instruction
Instructions de montage
Bouwhandleiding
Instrucciones de construcción
Manual de montagem
Istruzioni di montaggio
Инструкция по сборке
安装说明书

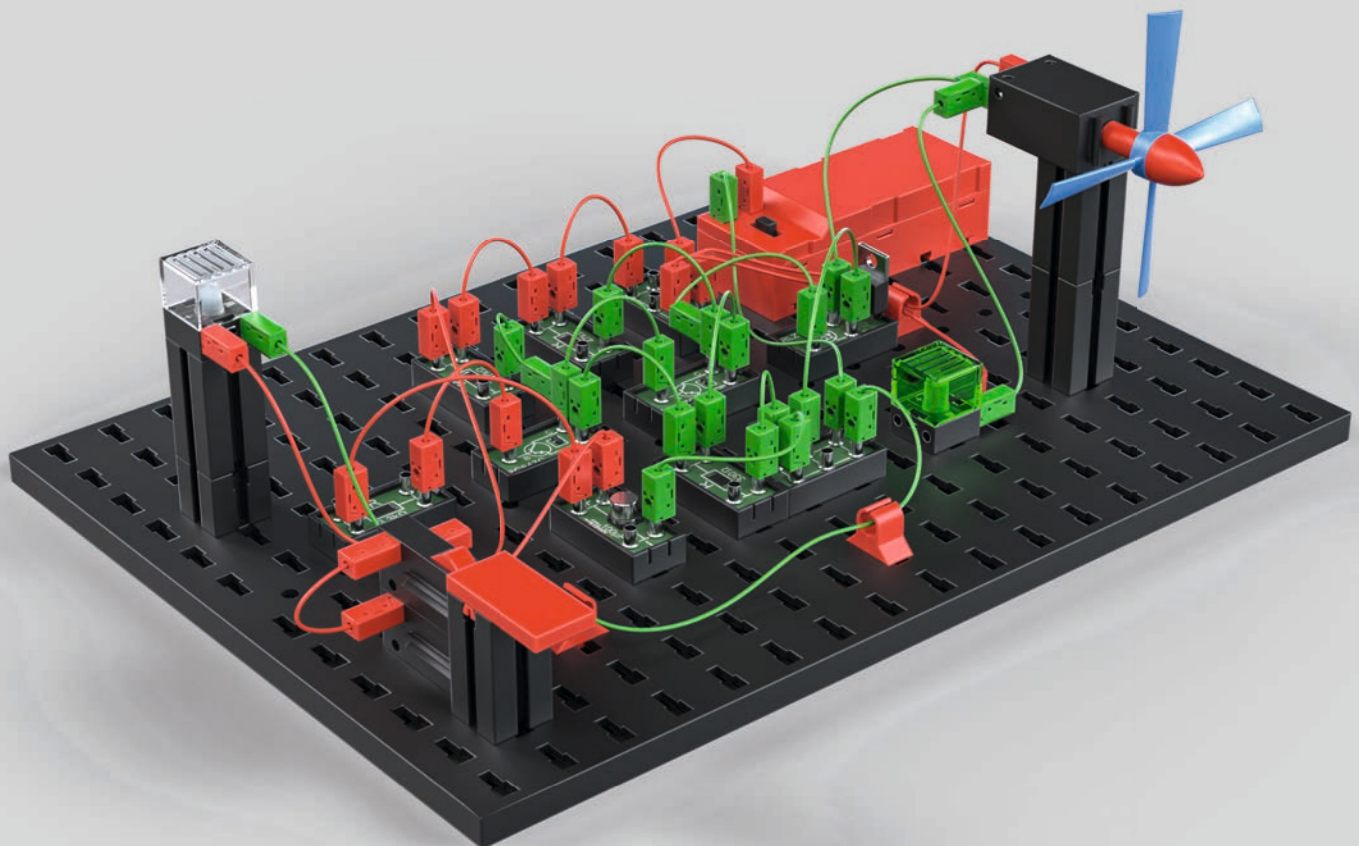

- Auf dem fischertechnik eLearning Portal bieten wir Ihnen die Möglichkeit, noch mehr Hintergrundwissen zum Thema des Baukastens zu erhalten und sich umfangreiche didaktische Begleitmaterialien für den Einsatz im Unterricht herunterzuladen. Über <https://www.fischertechnik.de/elearning-stemelectronics> gelangen Sie direkt zum eLearning Portal.
- On the fischertechnik eLearning portal, we offer you the opportunity to obtain even more background knowledge on the subject of the construction kit and to download extensive didactic accompanying materials for use in the classroom. You can access the eLearning portal directly via <https://www.fischertechnik.de/elearning-stemelectronics>.
- Avec le portail eLearning de fischertechnik, vous pouvez parfaire vos connaissances au sujet de la boîte de construction. Cliquez sur <https://www.fischertechnik.de/elearning-stemelectronics> pour accéder directement à notre portail.
- Met het fischertechnik eLearning portaal geven wij u de mogelijkheid, nog meer achtergrondkennis over het thema van het modulaire systeem te verkrijgen. Via <https://www.fischertechnik.de/elearning-stemelectronics> komt u direct bij het eLearning portaal.
- En el portal de eLearning de fischertechnik te ofrecemos la posibilidad de obtener aún más conocimientos de fondo sobre el tema del kit de construcción y de descargar amplios materiales didácticos de acompañamiento para utilizar en el aula. A través de <https://www.fischertechnik.de/elearning-stemelectronics> podrá acceder directamente al portal de aprendizaje electrónico.
- Com o portal de eLearning da fischertechnik damos lhe a possibilidade de obter ainda mais conhecimentos aprofundados sobre os kits de construção. Em <https://www.fischertechnik.de/elearning-stemelectronics> pode aceder diretamente ao portal de eLearning.
- Con il portale eLearning di fischertechnik vi diamo la possibilità di accumulare maggiori informazioni di base sul tema delle scatole di montaggio. Tramite <https://www.fischertechnik.de/elearning-stemelectronics> potete raggiungere direttamente il portale eLearning.
- Обучающий Интернет-портал компании fischertechnik предлагает вам возможность получить больше базовых знаний по теме конструирования. По ссылке <https://www.fischertechnik.de/elearning-stemelectronics> вы попадаете прямо на обучающий Интернет-портал.
- 通过 fischertechnik eLearning 电子学习门户网站，我们为您提供更多关于积木的背景知识。登陆 <https://www.fischertechnik.de/elearning-stemelectronics> 访问我们的 elearning 门户网站。

<https://www.fischertechnik.de/elearning-stemelectronics>



Inhalt
Contents
Contenu

Inhoud
Contenido
Conteúdo

Contenuto
Содержание
目录

Einzelteilübersicht / Spare parts list / Liste des pièces détachées / Onderdelenoverzicht / Lista da piezas / Resumo de peça individual /
Singoli componenti / Перечень деталей / 零件概览 4

Montagetipps / Tips for assembly / Tuyaux pour le montage / Montagetips / Consejos para el montaje / "Dicas" para montagem /
Consigli per il montaggio / Советы по сборке / 装配建议 5

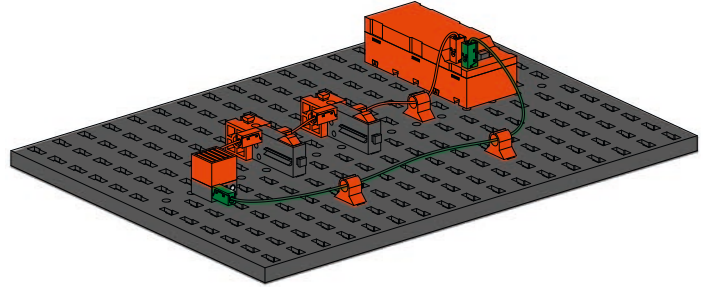
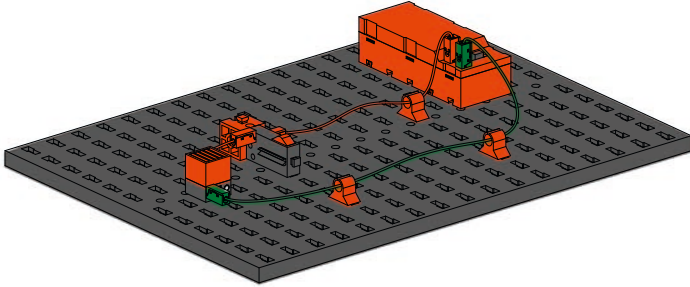

einfacher Stromkreis / Simple circuit / circuit simple / Eenvoudig stroomcircuit /
Circuito de corriente simple / circuito simples / Circuito semplice / простая схема
/ 简单的电路 7

UND Schaltung / AND circuit / Circuit ET / EN-schakeling / Circuito AND / E circuito /
Circuito AND / Схема И / 和电路 9

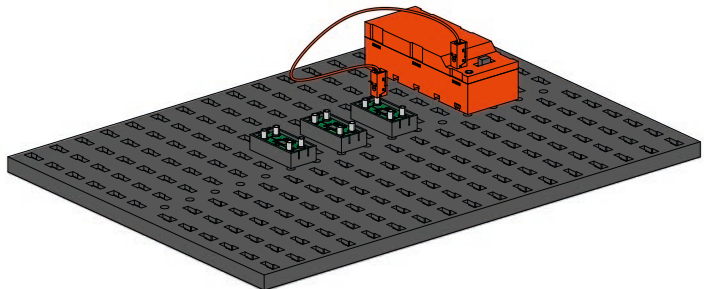
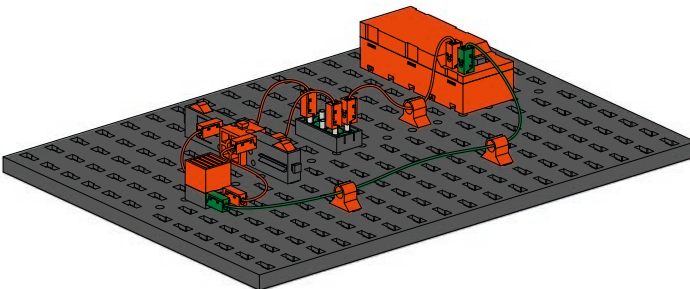

ODER Schaltung / OR circuit / Circuit OU / OF-schakeling / Circuito OR / OU Circuito /
Circuito OR / Схема ИЛИ / 或电路 11

Widerstand im Stromkreis / Resistance in the circuit / Résistance dans le circuit /
circuitweerstand / resistencia del circuito / resistor de circuito / Resistenza del circuito
/ Резистор в цепи / 电路电阻 14

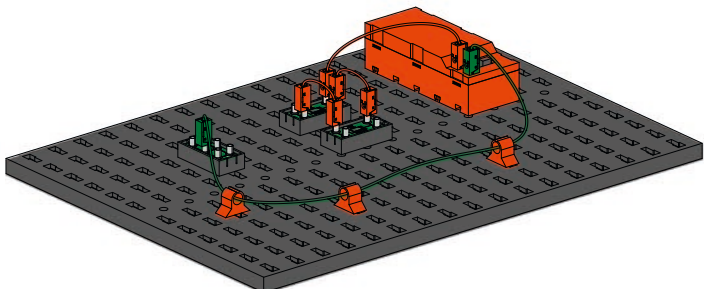
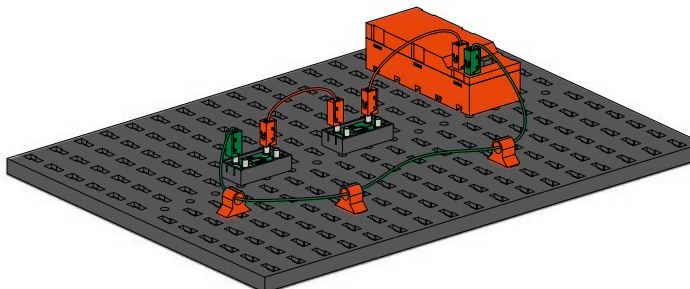

Widerstand Reihenschaltung / Resistance series connection / Résistance connexion
en série / Weerstand serieschakeling / Circuito de resistencias en serie / Conexão da Série de
Resistência / Resistenze in serie / Последовательное соединение
сопротивлений / 电阻系列连 16

Widerstand Parallelschaltung / Resistance parallel connection / Résistance connexion
parallèle / Weerstand parallelaansluiting / Circuito de resistencias en paralelo / Resistência
Conexão paralela / Resistenze in parallelo / Параллельное соединение
сопротивлений / 电阻 平行连接 19

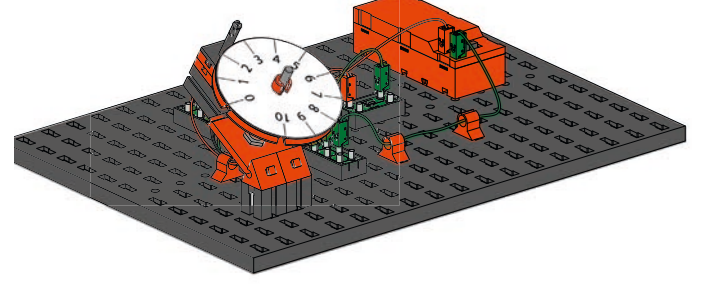
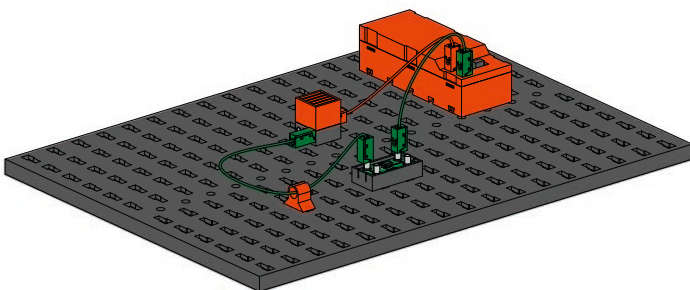

Diode / Diode / Diode / Diode / Diodo / Diodo / Diodo / Диод / 二极管
..... 22

Diode Kennlinie / Diode characteristic / Caractéristique de la diode / Diode
karakteristiek / Característica del diodo / Característica do Diodo / Caratteristica del
diodo / Характеристика диода / 二极管特性 25

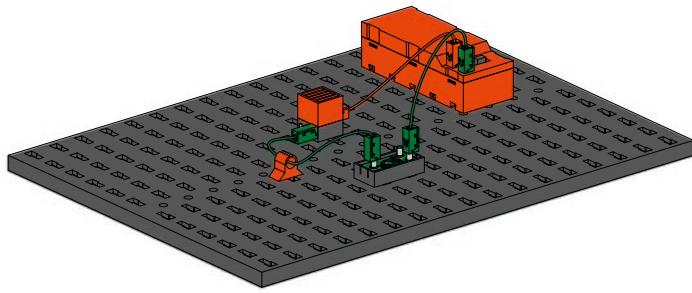

Transistor / Transistor / Transistor / Transistor / Transistor / Transistor / Transistor / Транзистор / 晶体管.....29

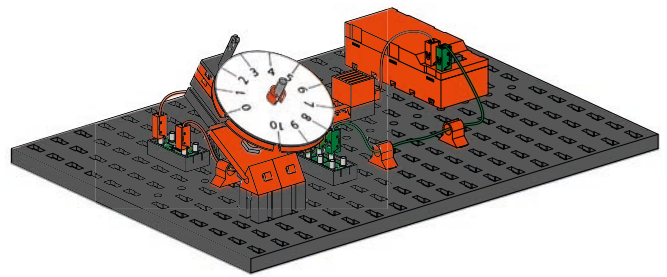

Transistor - einfache Schaltung / Transistor - simple circuit / Transistor - Circuit simple / Transistor - eenvoudige schakeling / Transistor - circuito simple / Transistor - comutação simples / Circuito semplice a transistor / Транзистор - простая схема подключения / 晶体管 - 简单电路.....32

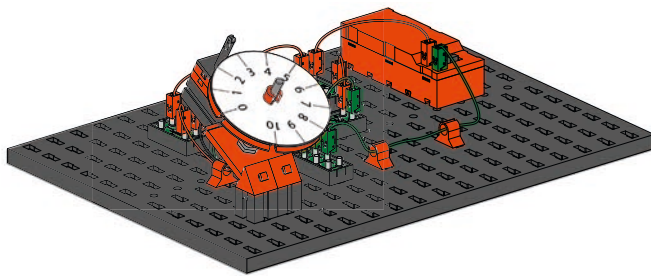

Transistorkennlinie / Transistor characteristic / Caractéristique du transistor / Transistorkarakteristiek / Característica del transistor / Característica do transistor / Caratteristica del transistor / Характеристика транзистора / 晶体管特性.....35

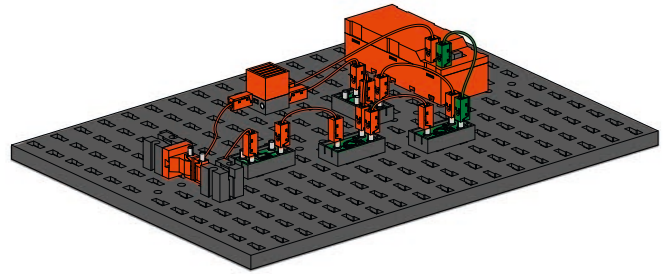

Darlingtonschaltung / Darlington circuit / Circuit Darlington / Darlingtontransistor / Transistor Darlington / Circuito de Darlington / Circuito Darlington / Схема Дарлингтона / 达林顿电路.....37

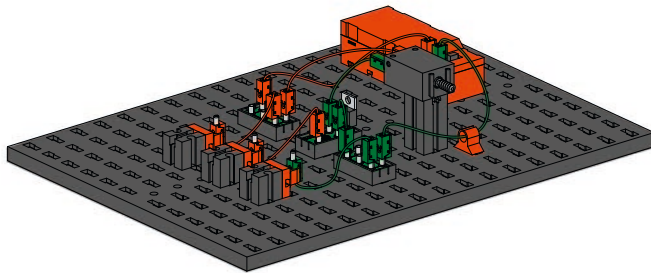

MOSFET / MOSFET / MOSFET / MOSFET / MOSFET / MOSFET / MOSFET / МОП-транзистор / 晶体管.....40

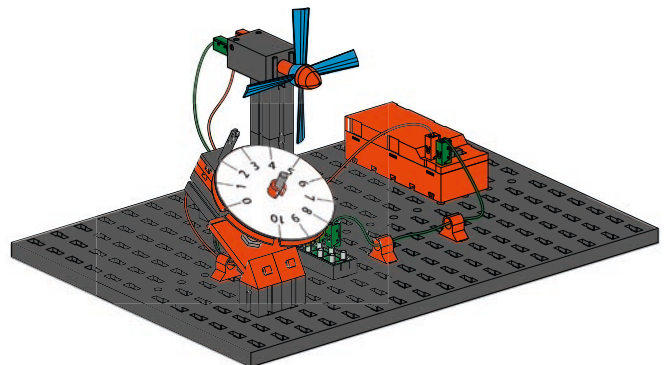

MOSFET - einfache Schaltung / MOSFET - simple circuit / MOSFET - circuit simple / MOSFET - eenvoudige schakeling / MOSFET - circuito simple / MOSFET - circuito simples / MOSFET - circuito semplice / МОП-транзистор - простая схема / 晶体管 - 简单电路.....43

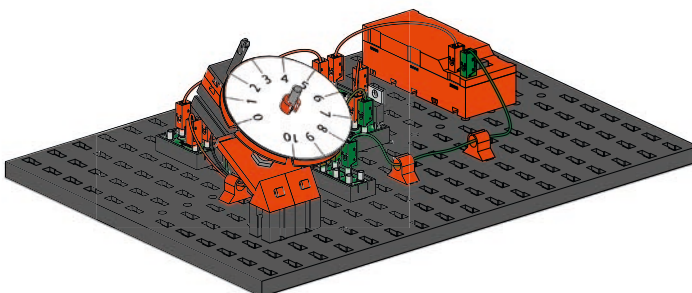

MOSFET Transferkennlinie / MOSFET transfer characteristic / Caractéristique de transfert du MOSFET / MOSFET overdrachtkarakteristiek / Característica de transferencia del MOSFET / Característica de transferência MOSFET / Caratteristica di trasferimento del MOSFET / Передаточная характеристика МОП-транзистора / 晶体管 传输特性.....46

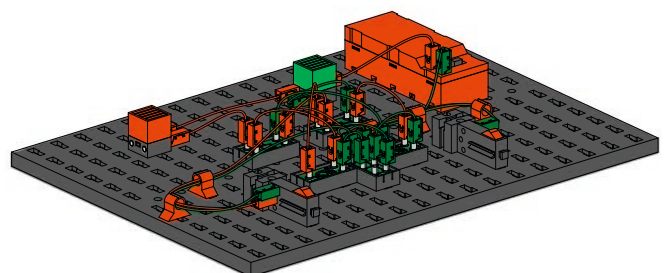

Bistabile Kippschaltung / Bistable tilt circuit / Interrupteur à bascule bistable / Bistabile kiepshakeling / Circuito basculante biestable / Interruptor de comutação biestável / Multivibratore bistabile / Бистабильный мультивибратор / 双稳态拨动开关.....48

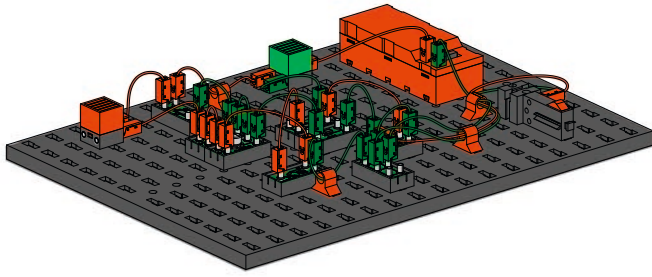

Monostabile Kippschaltung / Monostable toggle switch / Interrupteur à bascule monostable / Monostabiele kiepschakeling / Circuito basculante monoestable / Circuito de comutação monoestável / Multivibratore monostabile / Моностабильный мультивибратор / 单稳态拨动电路.....51

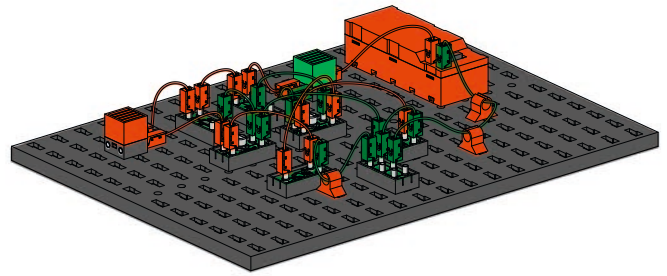

Astable Kippschaltung / Astable toggle switch / Interrupteur à bascule astable / Astabiele kiepschakeling / Circuito basculante aestable / Astable flip-flop / Multivibratore astabile / Астибильный мультивибратор / 雅士利触发电路.....54

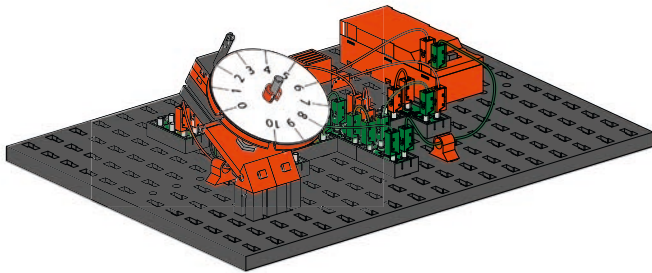

Schmitt-Trigger / Schmitt Trigger / Bascule de Schmitt / Schmitt-trigger / Disparador Schmitt / Gatilho Schmitt / Trigger di Schmitt / Триггер Шмитта / 施密特触发器.....57

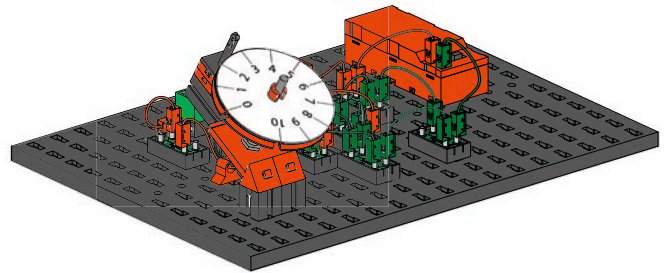

Differenzverstärker / Differential amplifier / Amplificateur différentiel / Differentiële versterker / Amplificador diferencial / Amplificatore differenziale / Дифференциальный усилитель / 差分放大器.....59

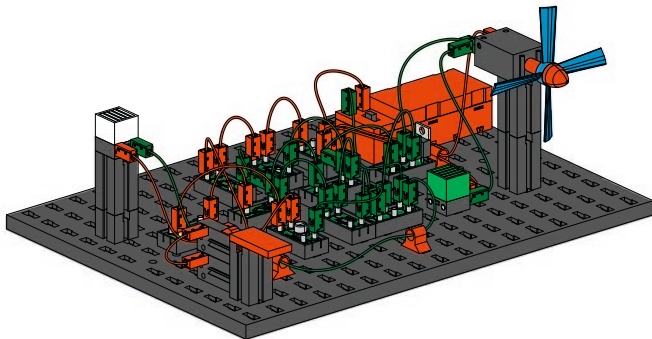

Badezimmerlüftung / Bathroom ventilation / Ventilation de salle de bains / Ventilatie in de badkamer / Ventilación de cuarto de baño / Ventilação da casa de banho / Ventilazione bagno / Вентиляция ванной комнаты / 浴室通风装置.....61

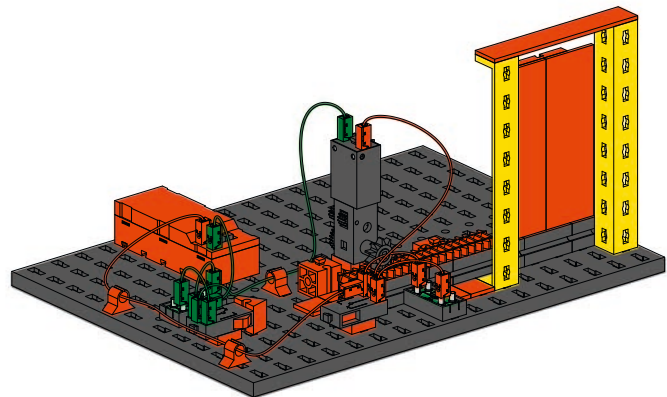

Schiebetür – Polwendesaltung mit Dioden / Sliding door - pole-changing circuit with diodes / Porte coulissante - inverseur de pôles avec diodes / Schuifdeur - poolwisselschakeling met diodes / Puerta corredera - circuito de cambio de polos con diodos / Porta deslizante - circuito de mudança de pólo com diodos / Porta scorrevole - Circuito di inversione della polarità con diodi / Раздвижная дверь с диодным переключателем полярности / 推拉门--带二极管的换极电路.....65

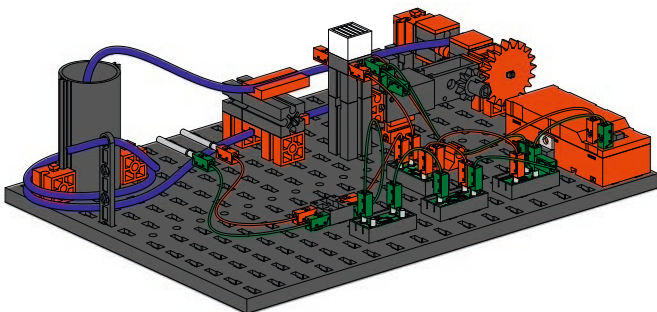













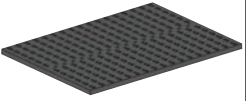







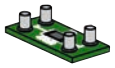













Gartenbewässerung / Garden irrigation / Arrosage du jardin / Tuin irrigatie / Riego de jardines / Irrigação de jardins / Irrigazione del giardino / Орошение сада / 花园灌溉.....71

Einzelteilübersicht
Spare parts list
Liste des pièces détachées

Onderdelenoverzicht
Lista da piezas
Resumo de peça individual

Singoli componenti
Перечень деталей
零件概览

	31 010 2 x		32 881 6 x		37 468 3 x		152 949 1 x
	31 011 1 x		32 985 1 x		37 679 1 x		156 107 1 x
	31 019 1 x		35 031 1 x		37 681 1 x		162 134 9V... / 0,01A 2 x
	31 053 1 x		35 049 2 x		37 783 2 x		181 583 27 x
	31 054 1 x		35 079 1 x		38 216 1 x		181 584 32 x
	31 058 1 x		35 084 1 x		38 245 1 x		185 511 47 kΩ 2 x
	31 060 1 x		35 086 1 x		38 246 4 x		185 512 3,3 kΩ 1 x
	31 061 1 x		35 319 2 x		38 251 2 x		185 513 330 Ω 1 x
	31 078 1 x		35 945 1 x		38 414 2 x		185 514 100µF 2 x
	31 082 1 x		35 969 5 x		38 428 1 x		185 515 SID 2 x
	31 597 6 x		36 294 2 x		130 593 2 x		185 516 BC847 C 2 x
	31 982 6 x		36 337 1 x		135 719 1 x		185 517 IRLI224N 1 x
	31 983 1 x		36 702 1 x		137 096 1 x		185 518 2 x
	32 064 7 x		36 703 1 x		137 677 1 x		186 184 1 x
	32 330 1 x		36 913 1 x		152 059 13 x		0 - 10 kΩ
	32 879 4 x		37 237 3 x		152 948 1 x		183 220 1 x

Montagetipps Tips for assembly Tuyaux pour le montage

1

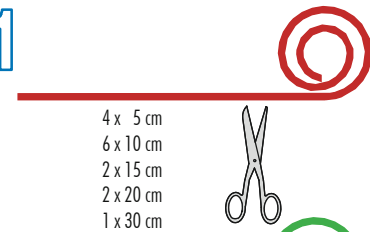

4 x 5 cm
6 x 10 cm
2 x 15 cm
2 x 20 cm
1 x 30 cm

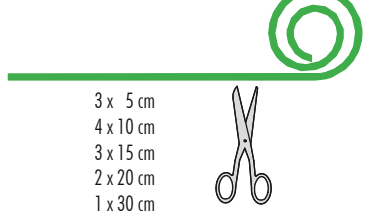

3 x 5 cm
4 x 10 cm
3 x 15 cm
2 x 20 cm
1 x 30 cm

2

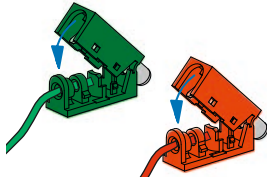

Montagetipps Consejos para el montaje "Dicas" para montagem

3

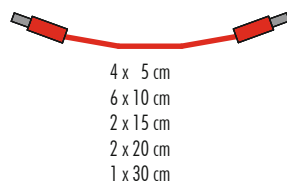

4 x 5 cm
6 x 10 cm
2 x 15 cm
2 x 20 cm
1 x 30 cm

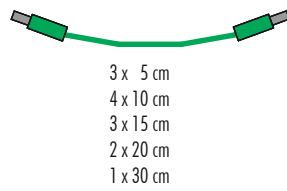

3 x 5 cm
4 x 10 cm
3 x 15 cm
2 x 20 cm
1 x 30 cm

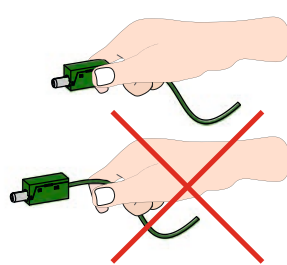

Consigli per il montaggio Советы по сборке 装配建议

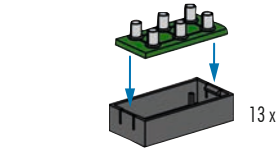

13 x

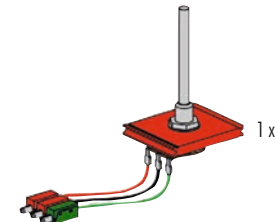

1 x

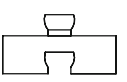
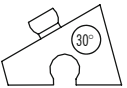
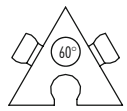

Ratschläge an überwachende Erwachsene

Advice for supervising adults

Recommandations à l'attention des adultes chargés de la surveillance

- Ausschließlich für Kinder von mindestens 8 Jahren geeignet.
Die Anleitungen sollen den Erwachsenen befähigen die Experimente im Hinblick auf die Eignung für das betreffende Kind abzuschätzen.
- Not intended for children under 8 years of age.
The instructions are intended to enable adults to assess the experiment's suitability for the child concerned.
- Boîte exclusivement appropriée aux enfants de plus de 8 ans.
Les instructions devraient permettre aux adultes d'évaluer si l'enfant concerné est apte à effectuer les essais respectifs.

Adviezen voor de volwassene die toezicht houdt

Consejos de supervisión para adultos

Conselhos para os adultos vigilantes

- Uitsluitend geschikt voor kinderen vanaf minimaal 8 jaar.
De gebruiksaanwijzingen dienen als hulp voor de volwassene om te kunnen beoordelen of de experimenten geschikt zijn voor het desbetreffende kind.
- Adecuado exclusivamente para niños de mínimo de 8 años.
Las instrucciones deben facultar al adulto de evaluar el experimento con miras a su adecuación para el niño afectado.
- Adequado exclusivamente para crianças com, no mínimo, 8 anos.
As instruções devem capacitar os adultos a avaliar os experimentos em relação à sua adequação para a criança pertinente.

Consigli per gli adulti che sorvegliano

Советы контролирующим взрослым

给进行监督的成人的建议

- Adatti esclusivamente per bambini di almeno 8 anni di età.
I manuali devono consentire all'adulto di saper valutare gli esperimenti in merito alla loro adeguatezza per il bambino in questione.
- Только для детей старше 8 лет.
Эти инструкции дают взрослым возможность оценить эксперименты с точки зрения их пригодности для ребёнка.
- 只适合于 8 岁以上的儿童
说明书应该能让成人判断该实验是否适合想做实验的孩子玩。

- Lies die Anleitung vor Versuchsbeginn, befolge sie und halte sie nachschlagebereit.
Bewahre den Experimentierkasten außerhalb der Reichweite von kleinen Kindern auf.
Alle Einzelteile, insbesondere bewegliche Teile sind falls notwendig zu warten und zu reinigen.
Achtung! Verletzungsgefahr an Bauteilen mit funktionsbedingten scharfen Kanten und Spitzen!

- Read these instructions before starting experiments; ensure they are followed and kept readily available for reference.
Keep the experiment kit out of reach of small children.
All components, especially moving parts, should be maintained and cleaned as necessary.
Caution! Be careful not to hurt yourself on components with sharp or pointed edges!

- Lisez le mode d'emploi avant de commencer les essais, suivez-le et maintenez-le à disposition afin que vous puissiez le consulter à tout moment.
Rangez la boîte expérimentation hors de portée de mains des enfants en bas âge.
Toutes les pièces détachées et en particulier les pièces mobiles, sont, si nécessaire, à entretenir et à nettoyer.
Attention! Risque de blessure sur les éléments comportant des arêtes et o pointes vives indispensables au bon fonctionnement!

- Lees de gebruiksaanwijzing voor het begin van het experiment door, volg de aanwijzingen erin op en houd haar binnen handbereik voor als u het niet meer weet.
Houd de experimenteerdoos uit de buurt van kleine kinderen.
Alle onderdelen, vooral de bewegende delen, kunnen, indien noodzakelijk, onderhouden en gereinigd worden.
Let op! U kunt zich bezeren aan bouwstenen met scherpe randen of punten!

- Lee estas instrucciones antes de iniciar el ensayo, cúmplelas y tenlas a mano para consultas.
Guarda la caja de experimentación fuera del alcance de niños pequeños.
Es necesario limpiar y mantener en buen estado todas las diferentes piezas - especialmente las piezas móviles.
Attenzione! Esiste il pericolo di lesione con i pezzi di costruzione che hanno bordi e punte spigolosi necessari per la funzionalità del pezzo!

- Leia as instruções antes do início do experimento, observe-as e mantenha-as sempre à mão para verificação.
Guarde a caixa de experimentos fora do alcance de crianças pequenas.
Caso necessário, todas as peças individuais, especialmente peças móveis, tem que ser submetidas à manutenção e ser limpas.
Atenção! Perigo de ferimentos em peças componentes com cantos vivos e pontas obrigatórios para o funcionamento!

- Leggi le istruzioni prima di iniziare l'esperimento, rispettate e tienle a portata di mano per poterle consultare in caso di bisogno.
Conserva la cassetta di sperimentazione lontano dalla portata dei bambini piccoli.
Se necessario, tutti i singoli componenti, soprattutto le parti mobili, si devono eventualmente sottoporre a manutenzione e pulizia.
Attenzione! Pericolo di lesioni dovute a componenti con spigoli vivi e punte per motivi funzionali!

- Прочитай инструкцию до начала эксперимента, выполняй её требования и держи наготове, чтобы обратиться к ней при необходимости.
Храни набор для экспериментов в месте, недоступном для маленьких детей.
Все детали, особенно подвижные, требуют ухода и чистки.
Будьте осторожны! Об острые края деталей и и наконечники можно порезаться!

- 请在使用前阅读说明书，并遵守及妥善保管，以备将来参考。
实验构件要存放在幼儿够不到的地方。
必要时应保养和清洁所有零件，尤指运动部件。
注意！
因功能需要而带有锋利的棱边和尖角的部件可能会带来受伤危险！

25 cm
20 cm
15 cm
10 cm
5 cm
0

Sicherheitshinweise Safety Information Consignes de sécurité

Veiligheidsrichtlijnen Indicaciones de seguridad Observações sobre segurança

Informazioni per la sicurezza Указания по технике безопасности 安全指南

- Das Spielzeug darf nur mit einer der folgenden fischertechnik Energiequellen benutzt werden: Art.-Nr.: 135719 Batteriehalter 9V oder Art.-Nr.: 35537 Accu Pack 8,4V.
- The toy may only be used with one of the following fischertechnik energy sources: Art No.: 135719 battery tray 9V or Art No.: 35537 Accu Pack 8.4V. You are not allowed to use 9V NiMH accu packs in this product.
- L'utilisation de ce jouet n'est permis qu'avec l'une des sources d'énergie fischertechnik suivantes: Art. n° : 135719 support de pile 9 volts ou Art. n° : 35537 pack d'accumulateurs 8,4 volts.
- Het speelgoed mag uitsluitend met een van de volgende fischertechnik energiebronnen worden gebruikt: art.nr.: 135719 batterijhouder 9V of art.nr.: 35537 accupack 8,4V
- El juguete se debe utilizar únicamente con una de las siguientes fuentes de energía: Art. No. 135719 soporte de pila de 9V o Art. No. 35537 paquete acumulador de 8,4V.
- O brinquedo somente pode ser utilizado com uma das seguintes fontes de energia da fischertechnik: art. n.º: 135719 Suporte de bateria de 9 V ou art. n.º: 35537 Bloco de bateria de 8,4V.
- Questo giocattolo può essere utilizzato solo con le seguenti fonti di energia fischertechnik: cod. prod.: 135719 portabatteria da 9V oppure cod. prod.: 35537 confezione batterie da 8,4V.
- Игрушку можно использовать только с одним из следующих источников энергии от fischertechnik: арт. №: 135719 держатель батарейки 9В или арт. №: 35537 Accu Pack 8,4В
- 该玩具只允许使用如下的慧鱼 (fischertechnik) 能量源：商品号：135719，9V 电池夹，或者商品号：35537，8.4V 电池套件 (Accu Pack)

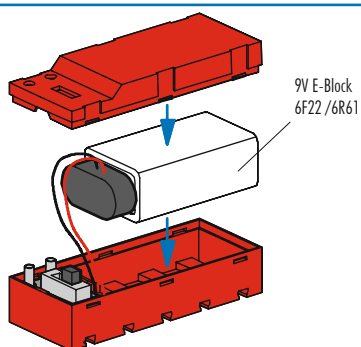

Multimeter Multimeter Multimetro
Multimeter Multímetro Мультиметр
Multimètre Multímetro 万用表

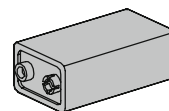

9V E-Block
6F22/6R61

- Nicht wiederaufladbare Batterien dürfen nicht geladen werden
- Aufladbare Batterien dürfen nur von Erwachsenen geladen werden
- Aufladbare Batterien sind aus dem Batteriehalter herauszunehmen, bevor sie geladen werden.
- Batterien müssen mit der richtigen Polarität einglegt werden.
- Leere Batterien müssen aus dem Spielzeug herausgenommen werden
- Die Anschlussklemmen dürfen nicht kurzgeschlossen werden.
- Verbrauchte Batterien dem Sondermüll zuführen.
- Drähte nicht in Steckdose einführen!
- Ladegerät regelmäßig auf Schäden überprüfen. Bei einem Schaden darf das Ladegerät bis zur vollständigen Reparatur nicht mehr verwendet werden.
- Alle elektrischen Bauteile (Motoren, Lampen) dürfen ausschließlich an Stromversorgungen von fischertechnik angeschlossen werden.
- Niet-oplaadbare batterijen mogen niet worden opgeladen.
- Oplaadbare batterijen mogen uitsluitend door volwassenen worden opgeladen.
- Oplaadbare batterijen moeten uit de batterijhouder worden verwijderd, voordat deze worden opgeladen.
- De batterijen moeten met de juiste polariteit worden geplaatst.
- Lege batterijen moeten uit het speelgoed worden verwijderd.
- De aansluitklemmen mogen niet worden kortgesloten.
- Afleveren gebruikte batterijen bij het klein chemisch afval (KCA).
- Geen draden in de contactdoos steken!
- Laadtoestel regelmatig controleren op schade. Bij schade mag het laadtoestel niet meer gebruikt worden tot het volledig hersteld is.
- Alle elektrische componenten (motoren, lampen) mogen uitsluitend op stroomvoorzieningen van fischertechnik worden aangesloten.
- Le batterie non ricaricabili non devono essere ricaricate
- Le batterie ricaricabili devono essere ricaricate da persone adulte
- Le batterie ricaricabili si devono estrarre dal supporto prima di ricaricarle.
- Le batterie si devono inserire rispettando la polarità.
- Togliere le batterie dal giocattolo quando sono scariche
- I morsetti di allacciamento non devono essere cortocircuitati.
- Smaltire le batterie usate negli appositi contenitori per la raccolta differenziata.
- Non inserire i fili nella presa elettrica.
- Controllare periodicamente se il caricabatterie presenta dei danni. In caso di danni, il caricabatterie non deve più essere utilizzato fino alla riparazione.
- Tutti i componenti elettrici (motori, lampadine) devono essere collegati esclusivamente ad alimentatori fischertechnik.
- Не пытайтесь заряжать перезаряжаемые батарейки.
- Зарядку перезаряжаемых аккумуляторов разрешается выполнять только взрослым.
- Перед зарядкой перезаряжаемых аккумуляторов извлеките их из аккумуляторного отсека.
- При установке аккумуляторов на место соблюдайте полярность.
- Разряженные батарейки необходимо извлечь из игрушки.
- Не замыкайте коротко соединительные клеммы.
- Использованные батареи утилизировать как спецотходы.
- Не вставляйте в розетку провода!
- Регулярно проверяйте зарядное устройство на отсутствие повреждений. При наличии повреждений использовать зарядное устройство до выполнения его полного ремонта не разрешается.
- Все электрические детали (электромоторы, лампочки.) можно подключать только к источникам электропитания от fischertechnik.
- 不得给非充电电池充电
- 只允许由成年人给充电电池充电
- 在充电前必须将充电电池从电池夹中取出。
- 必须按照正负极正确放入电池。
- 必须从玩具中取出没有电的电池
- 接线柱不允许被短路。
- 用完了的电池应作为特种垃圾处理。
- 禁止将金属丝插入插座！
- 经常检查充电器是否有损坏情况。如果充电器有损，直到完全修好为止不可以再使用。
- 只允许将所有电气部件（传感器，电机，灯泡）与慧鱼技术产品的电源装置相连接
- Las pilas no recargables no pueden ser cargadas
- Las pilas recargables sólo pueden ser cargadas por un adulto
- Las pilas recargables deben ser extraídas del compartimento de pilas antes de que sean cargadas.
- Las pilas deben ser colocadas con la polaridad correcta.
- Las pilas descargadas deben ser extraídas del juguete
- Los bornes de conexión no pueden ser puestos en cortocircuito.
- Retirar las baterías viejas, desechándolas en un depósito de basuras especiales.
- No introducir hilos en la toma de corriente!
- Comprobar con regularidad si el cargador presenta daños. En caso de presentar daños, el cargador no debe volver a ser utilizado hasta que esté completamente reparado.
- Todos los componentes eléctricos (motores, luces) deben conectarse a la alimentación de corriente de la técnica Fischer exclusivamente.
- Pilhas não recarregáveis não devem ser carregadas.
- Pilhas recarregáveis somente devem ser recarregadas por adultos.
- Pilhas recarregáveis devem ser retiradas do compartimento de pilhas antes de serem carregadas.
- As pilhas devem ser colocadas com a polaridade correta.
- As pilhas descarregadas devem ser retiradas do brinquedo.
- Os terminais de conexão não devem ser curto-circuitados.
- Eliminar as baterias esgotadas como desperdício perigoso
- Nunca introduzir fios na tomada!
- Verificar regularmente se o carregador apresenta danos. Em caso de dano, o carregador não deverá ser utilizado enquanto não estiver plenamente consertado.
- Todas as peças componentes elétricas (motores, lâmpadas) só podem ser exclusivamente conectadas em abastecimentos de corrente da Fischertechnik.



Hinweise zum Umweltschutz / Instructions for Environmental Protection / Remarques de protection de l'environnement / Bescherming van het milieu / Notas con respecto a la protección del medio ambiente / Instruções para a proteção do meio ambiente / Indicazioni sulla tutela ambientale / Указания по охране окружающей среды / 有关环保的提示：

www.fischertechnik.de/environment

einfacher Stromkreis
Simple circuit
Circuit simple

eenvoudig circuit
circuito simple
circuito simples

circuito semplice
простая схема
简单的电路

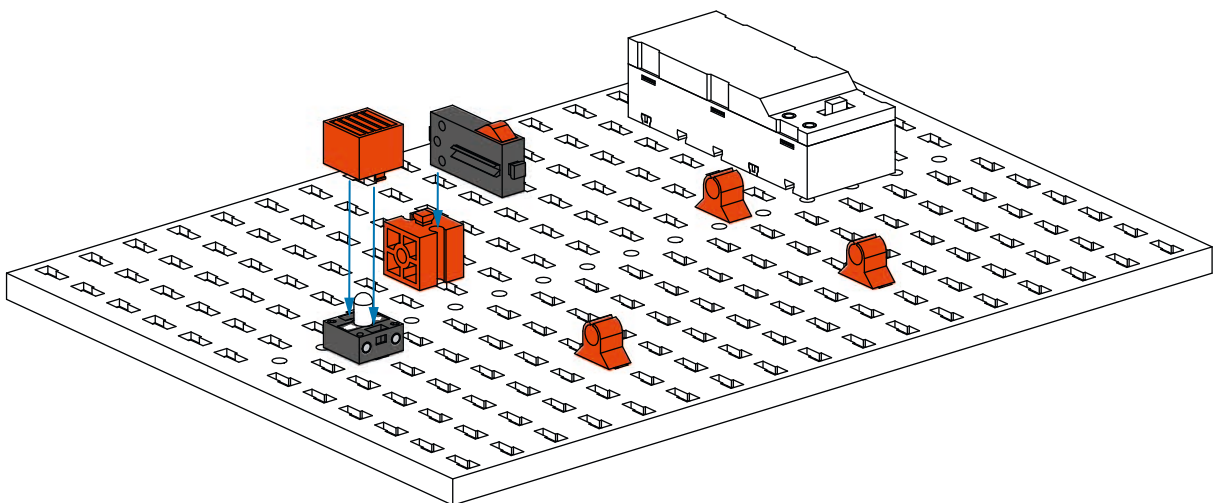
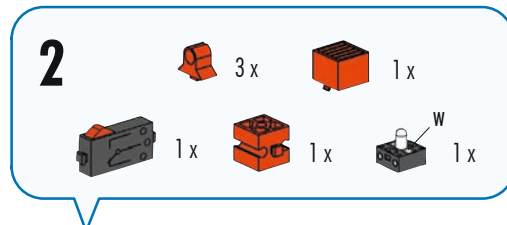
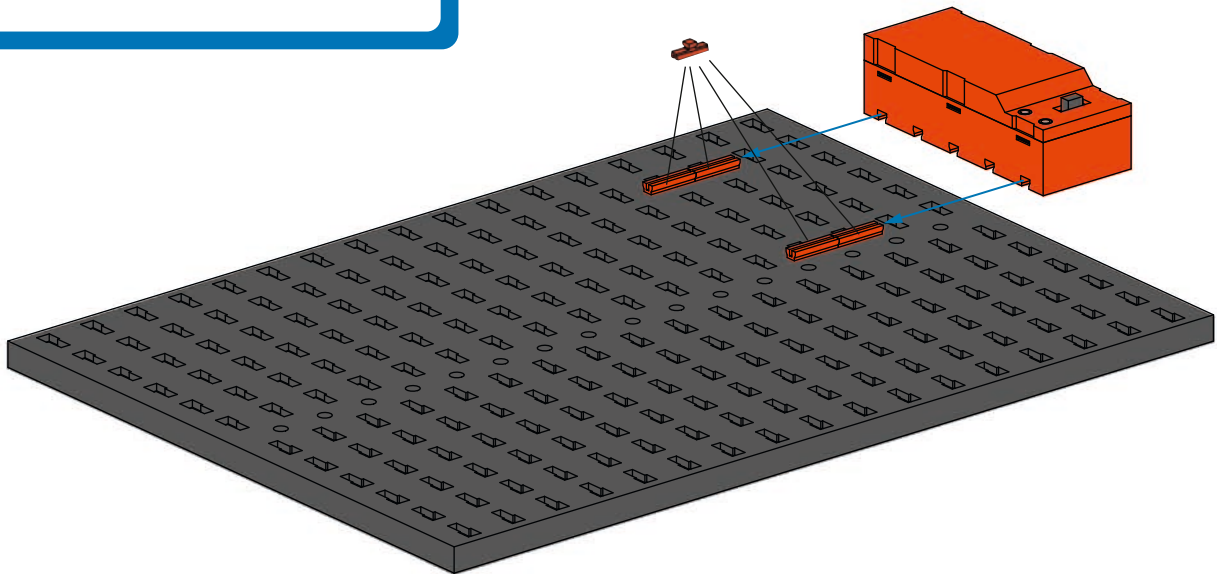
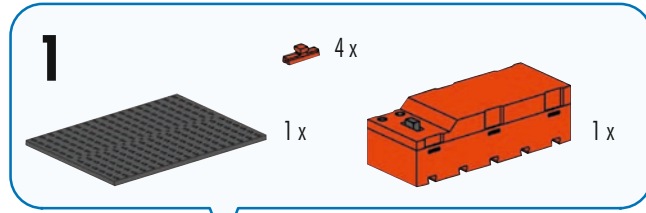
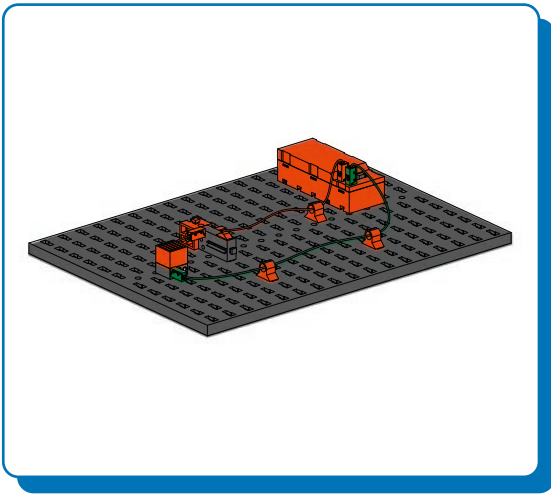

3

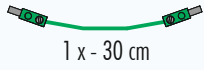

1 x - 30 cm



1 x - 10 cm
1 x - 15 cm

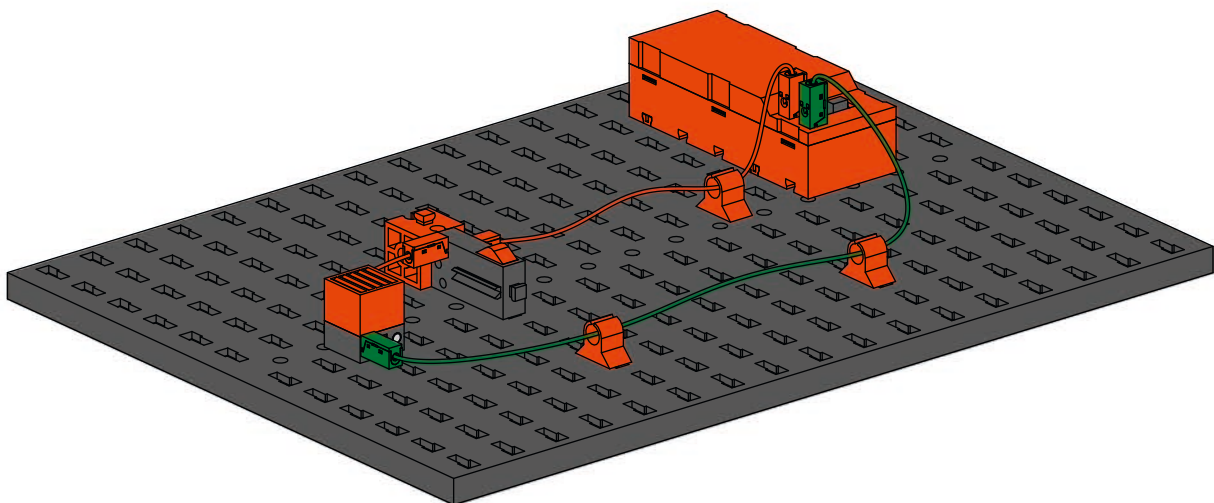
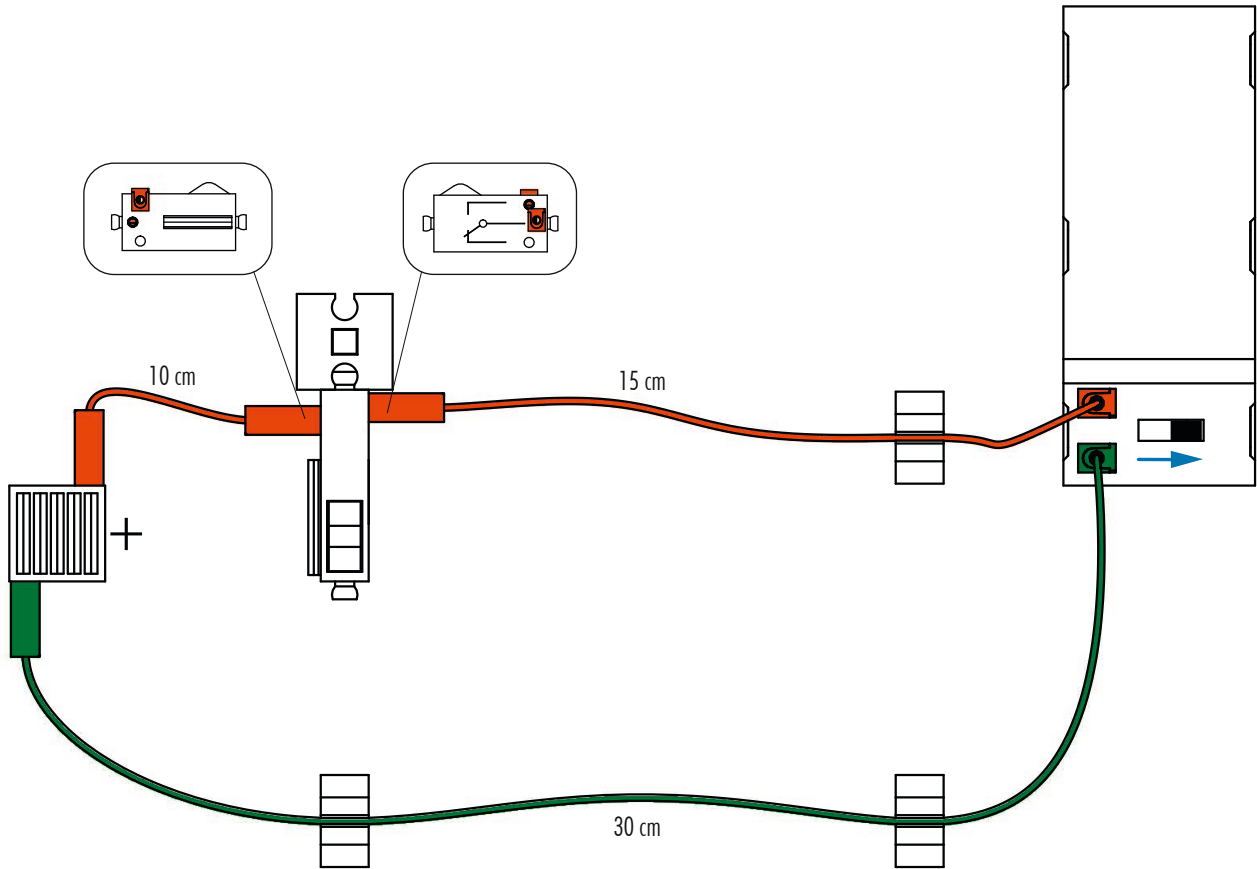

UND Schaltung
AND circuit
Circuit ET

EN-schakeling
Circuito AND
E circuito

Circuito AND
Cxema И
和电路

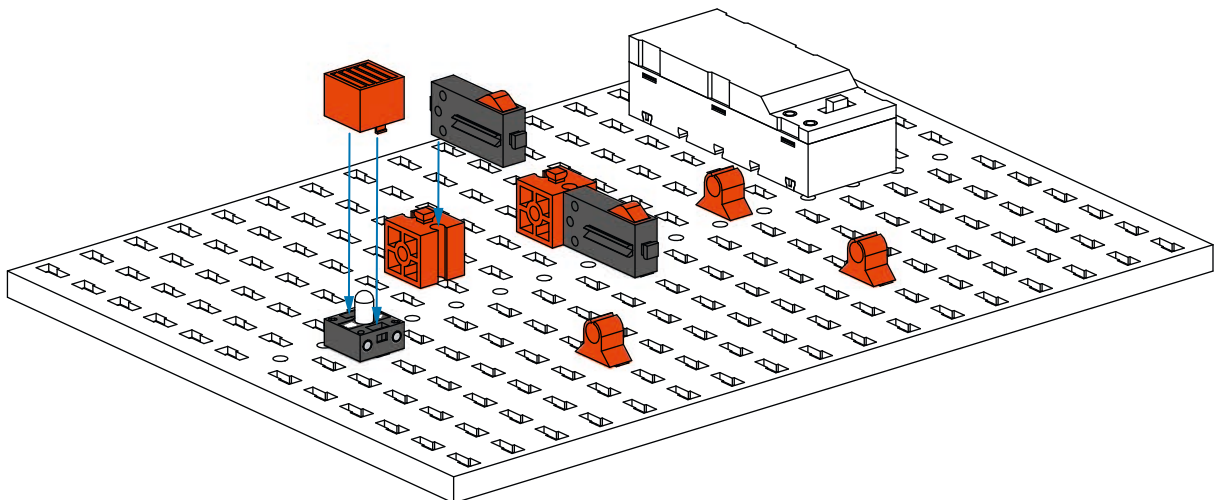
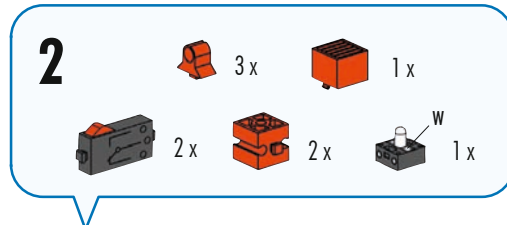
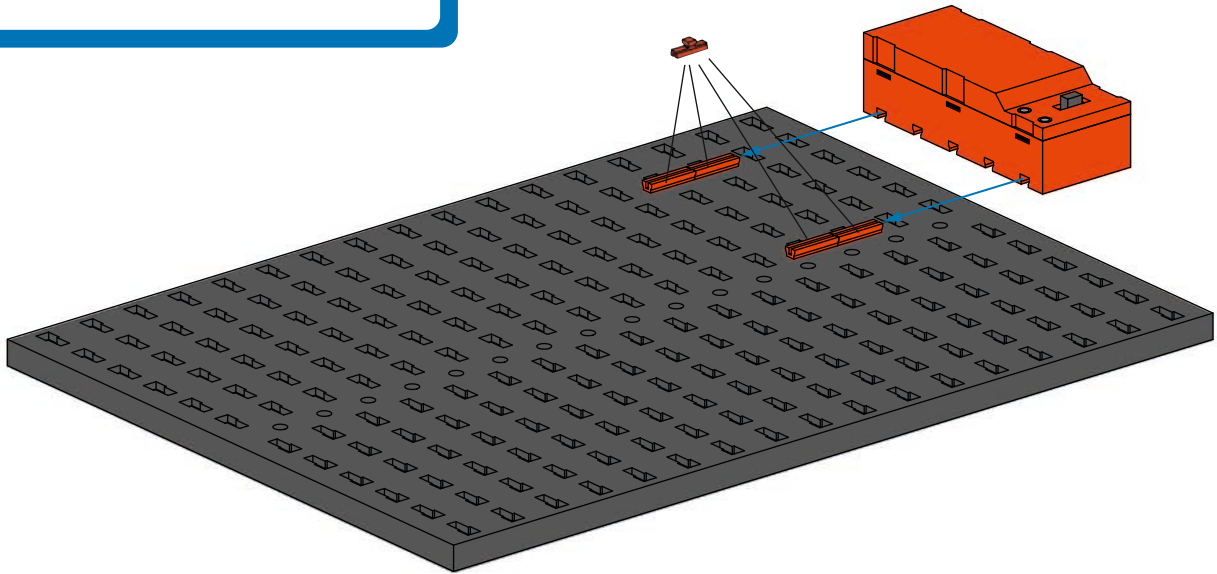
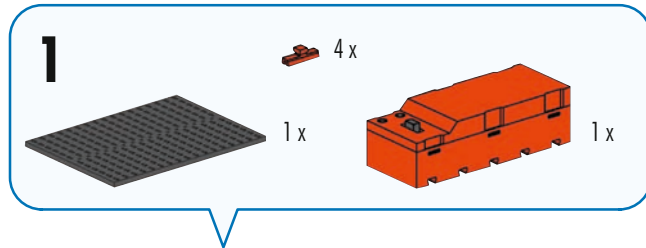
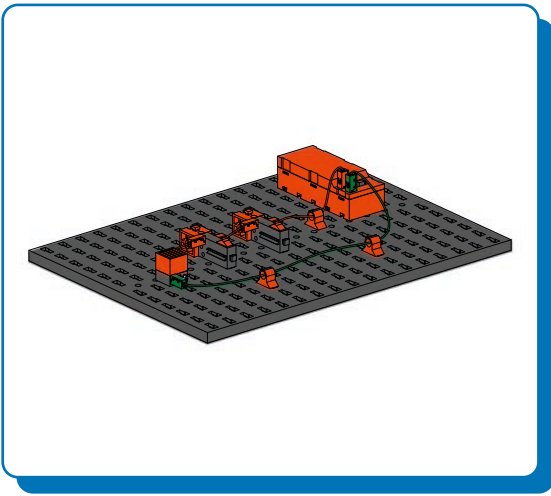

3

1 x - 30 cm

1 x - 10 cm
2 x - 5 cm

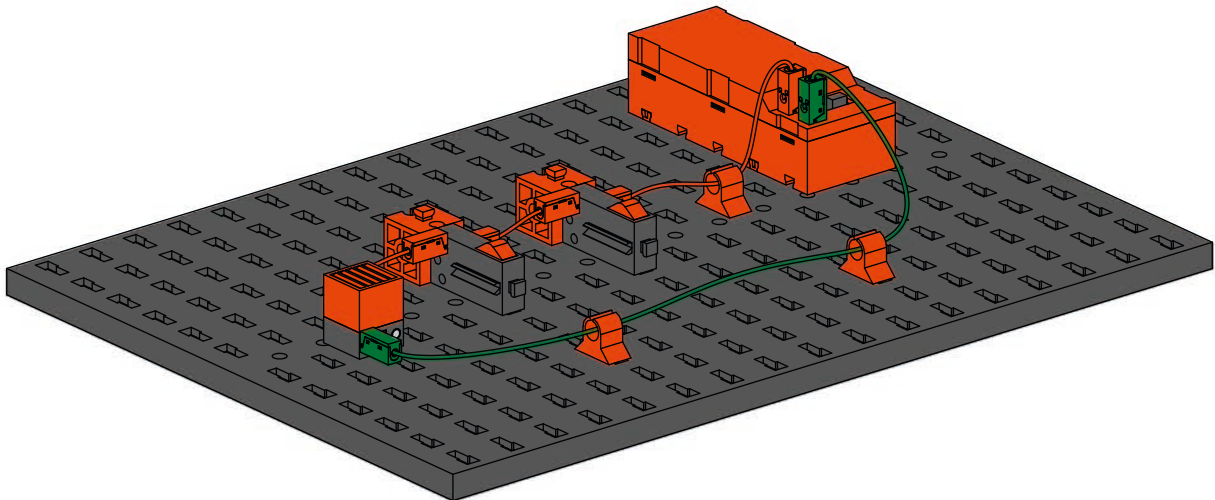
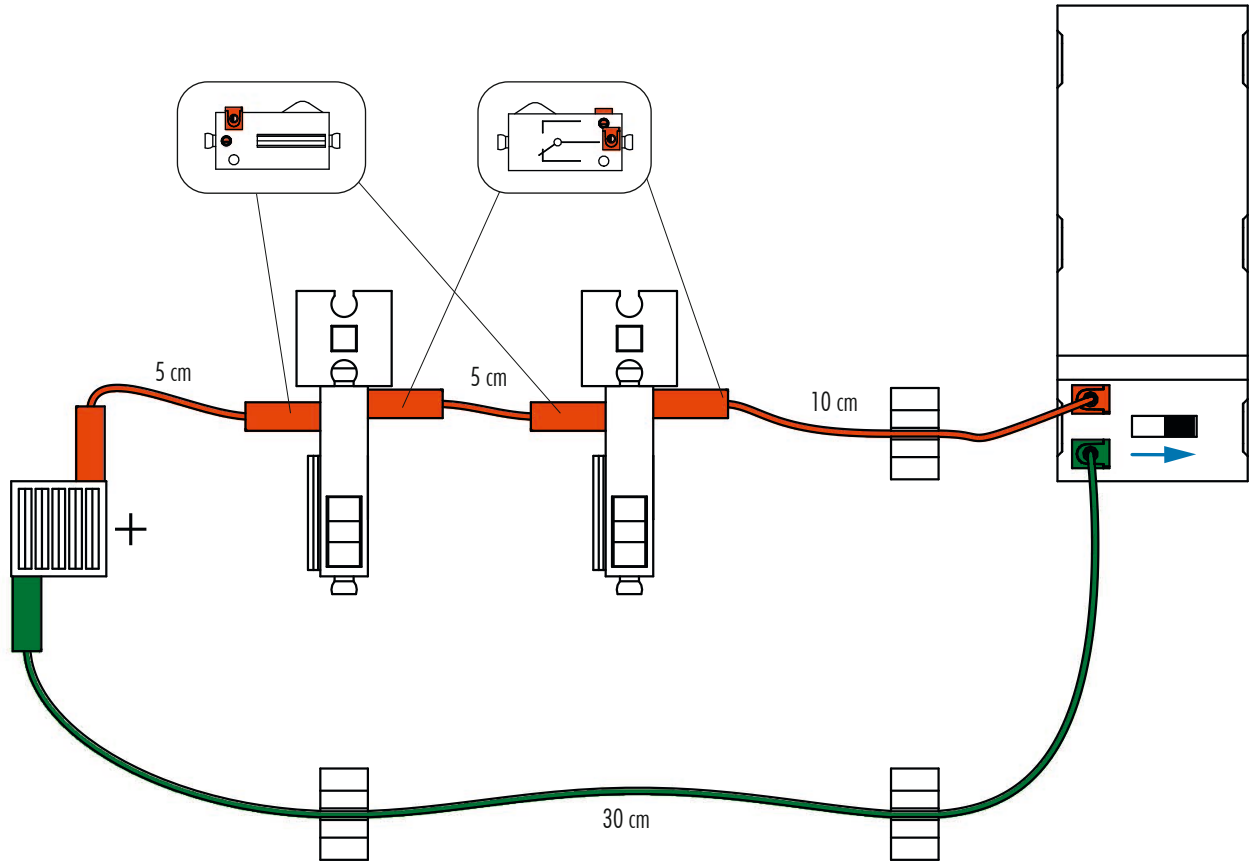

ODER Schaltung
OR circuit
Circuit OU

OF-schakeling
Circuito OR
OU Circuito

Circuito OR
Схема ИЛИ
或电路

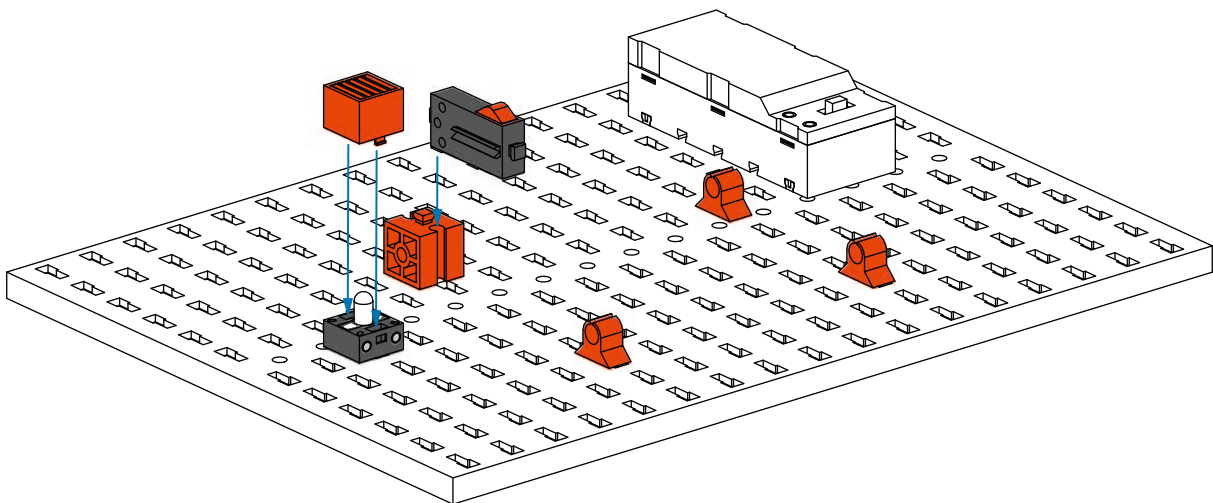
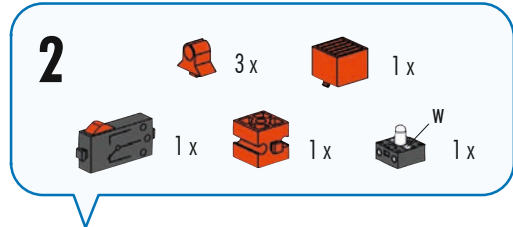
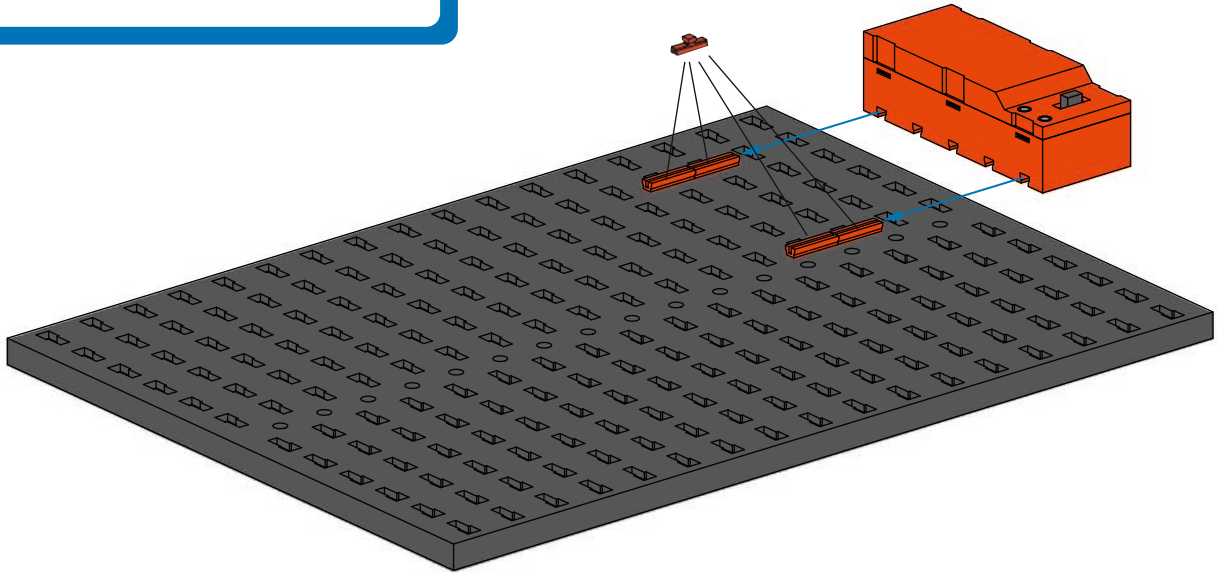
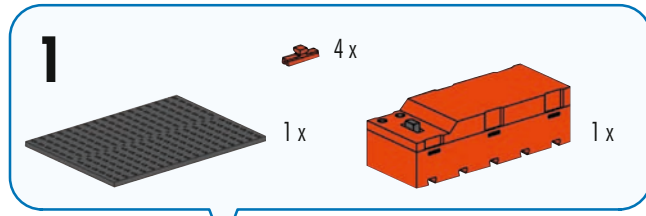
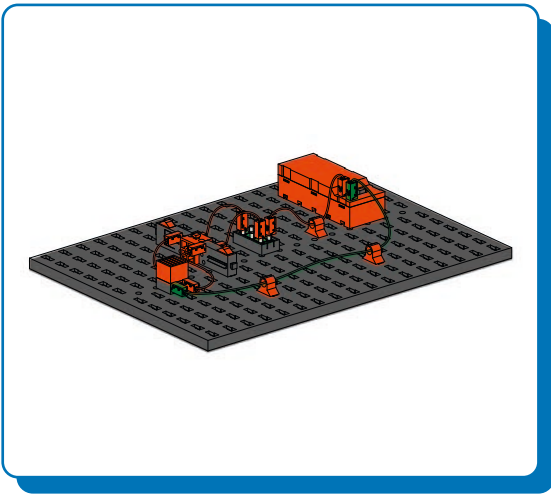

3

1 x  1 x 

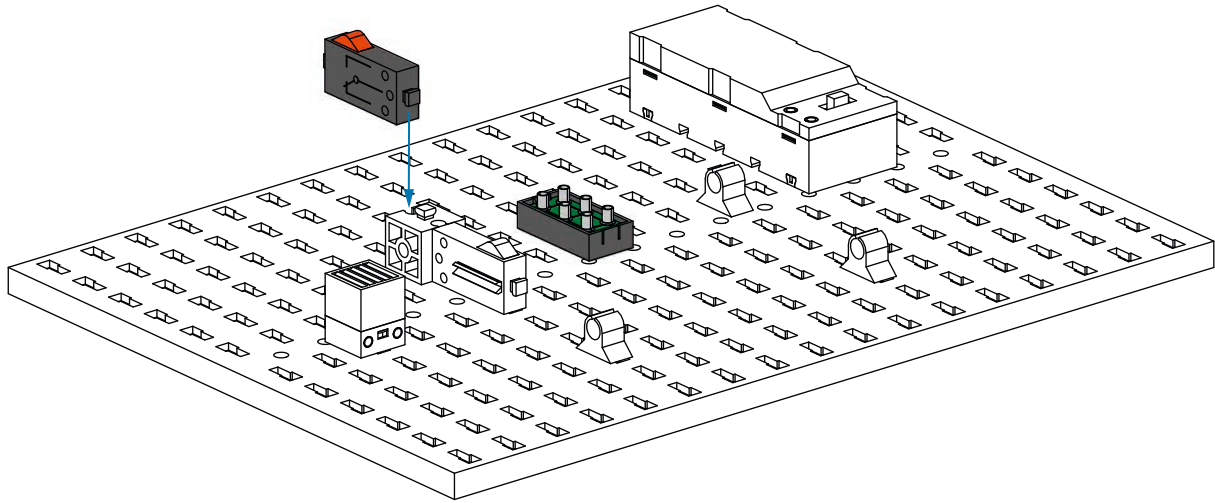

4

1 x - 30 cm

2 x - 5 cm

3 x - 10 cm

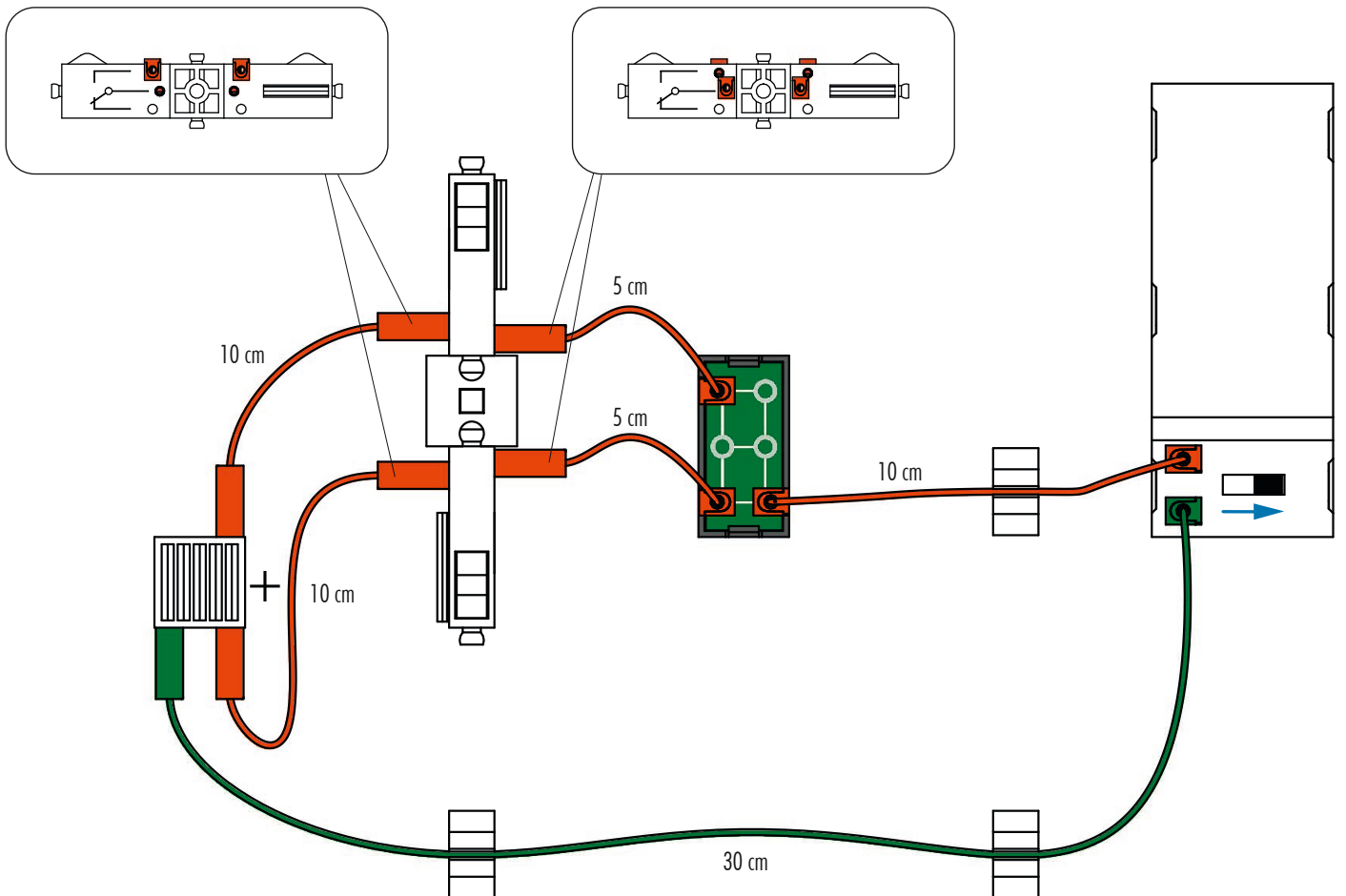

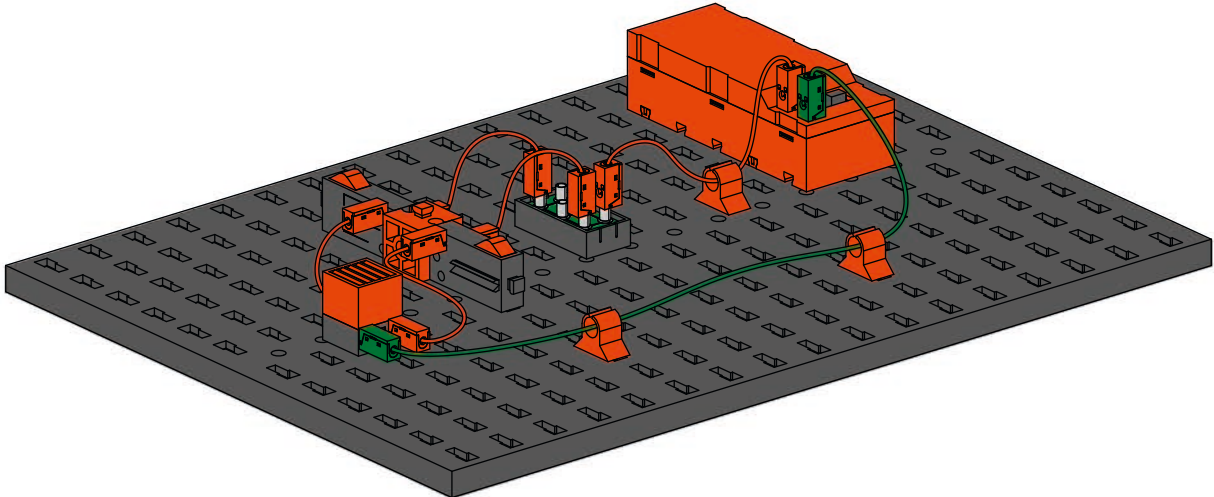

Widerstand im Stromkreis circuitweerstand Resistenza del circuito
 Resistance in the circuit resistencia del circuito Резистор в цепи
 Résistance dans le circuit resistor de circuito 电路电阻

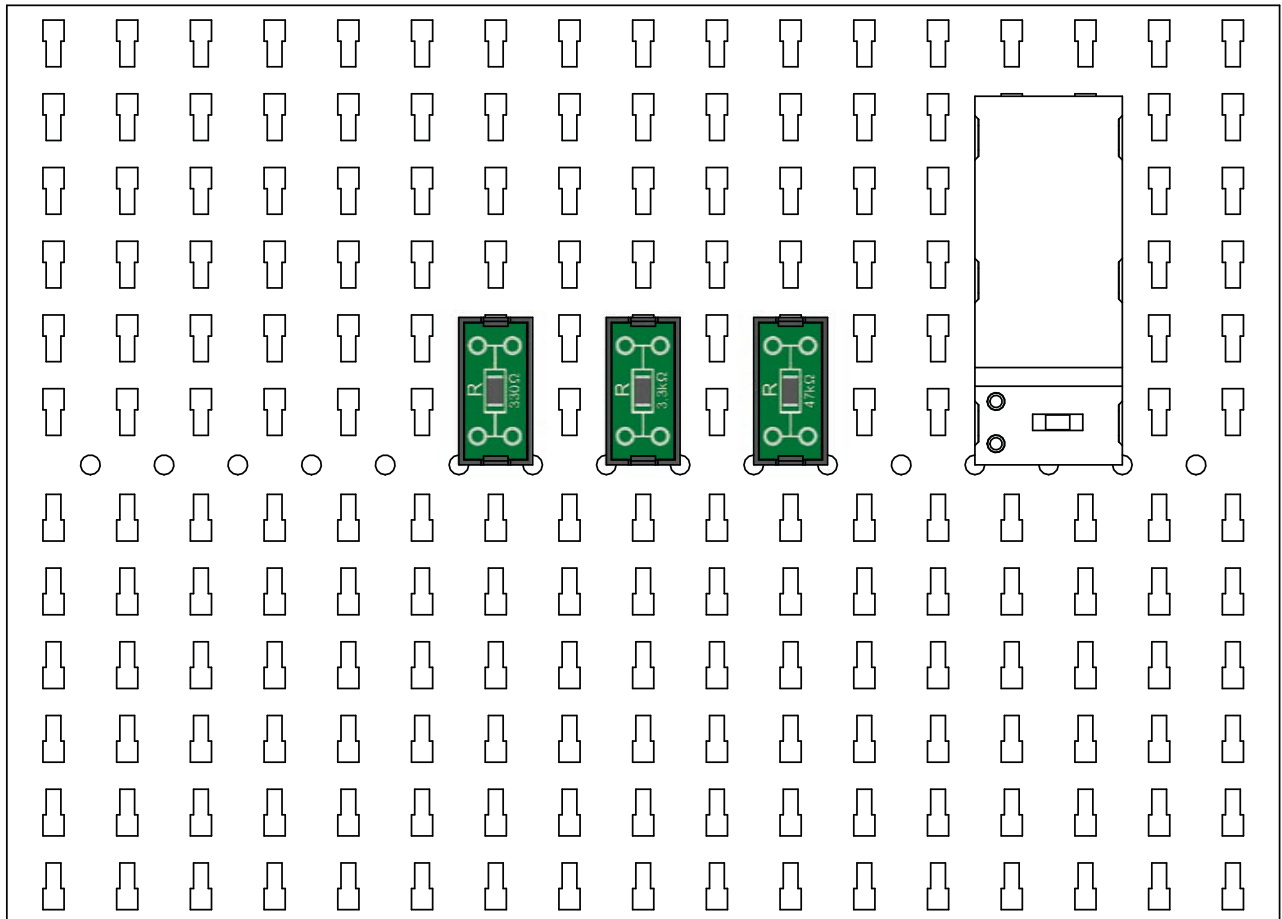
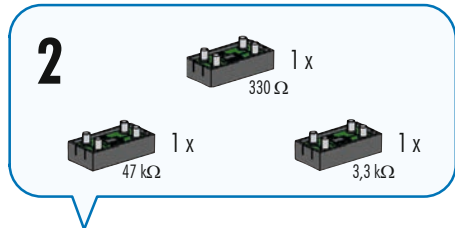
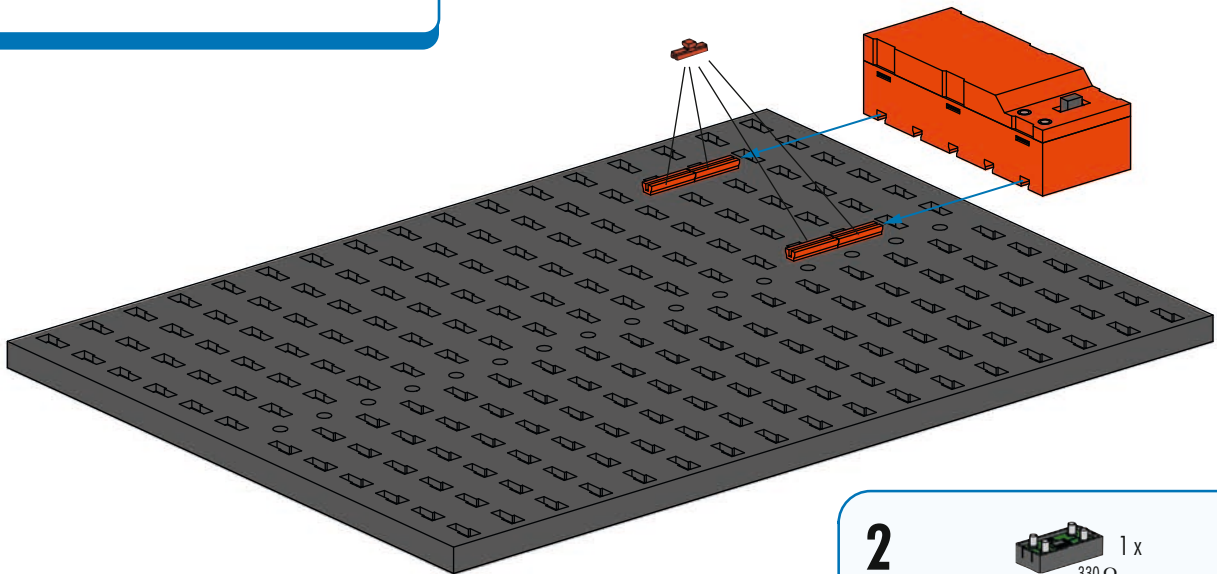
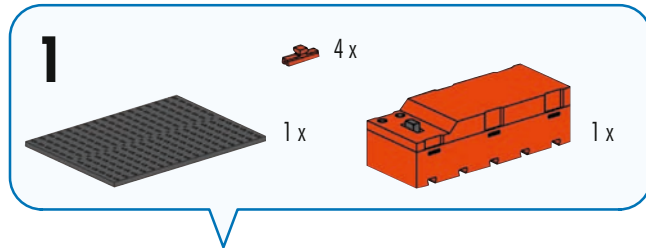
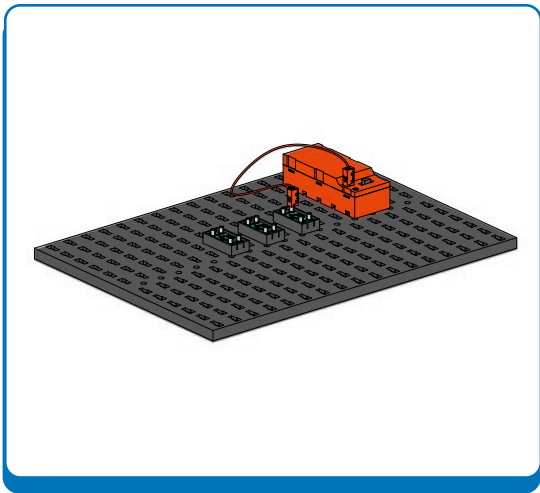

3
1 x - 15 cm

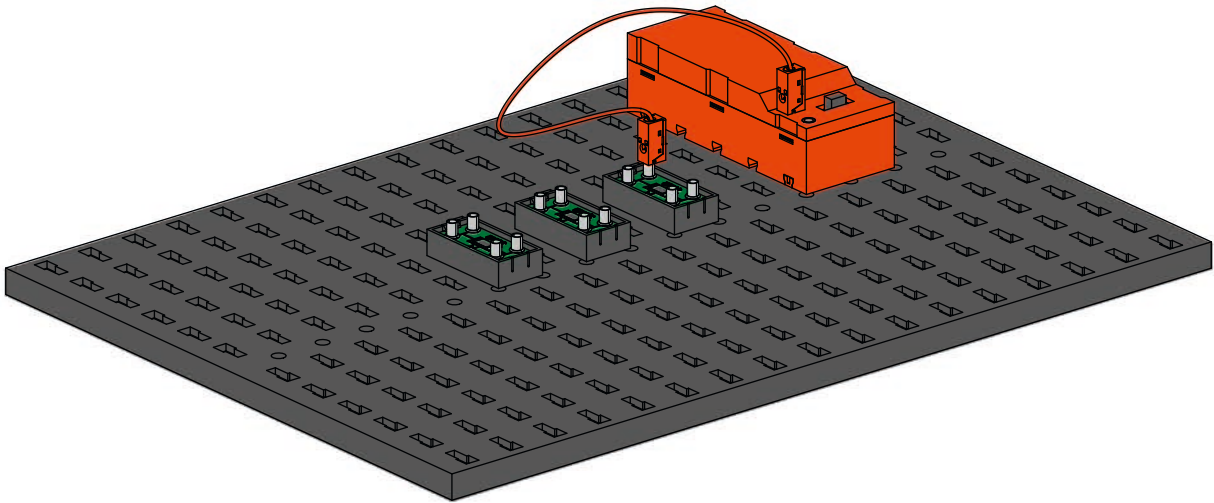
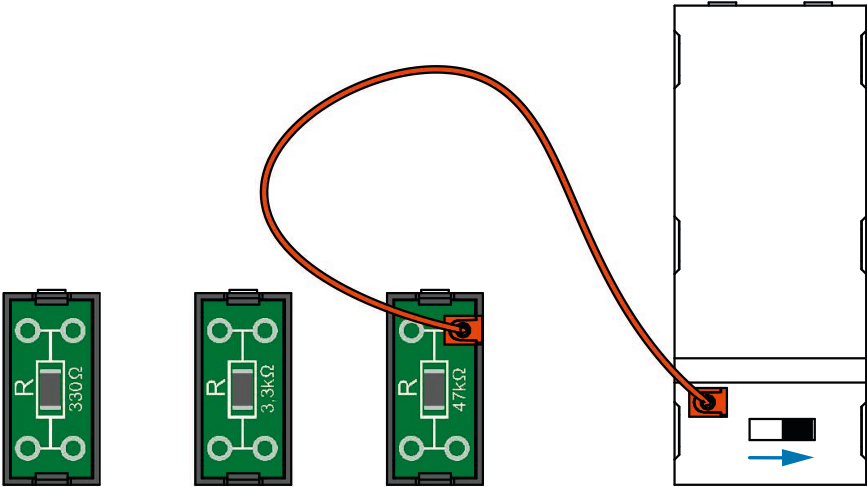

Widerstand Reihenschaltung
Resistance series connection
Résistance connexion en série
Weerstand serieschakeling

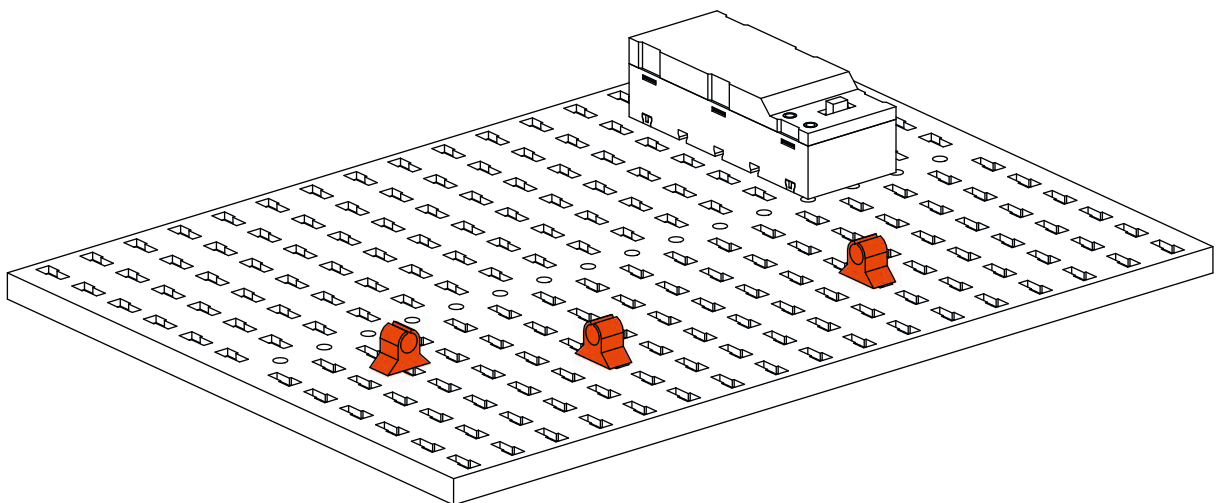
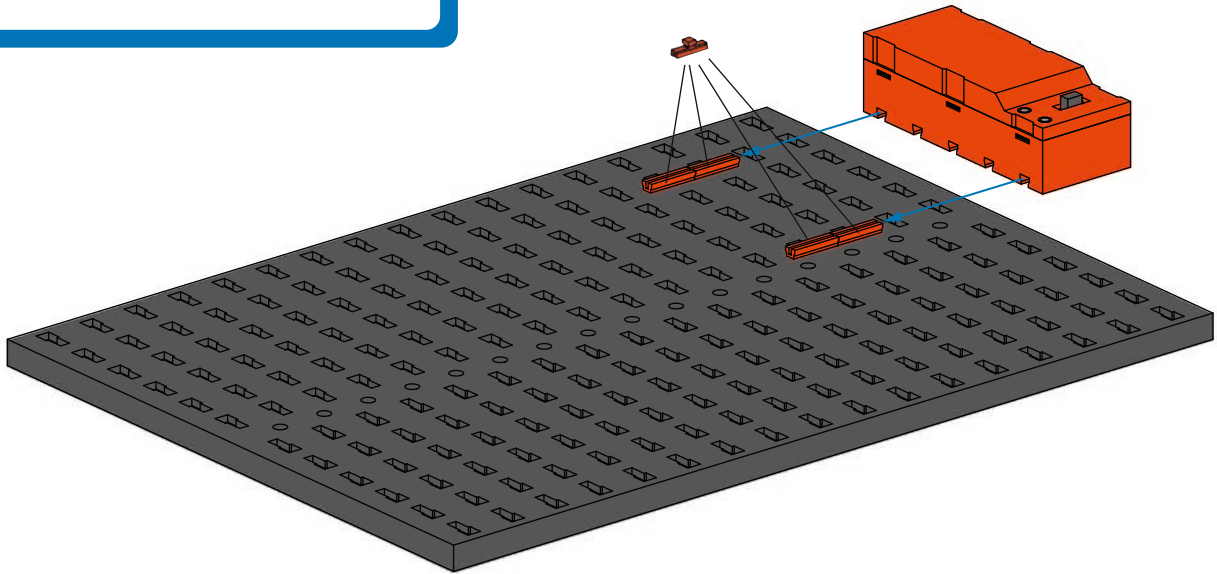
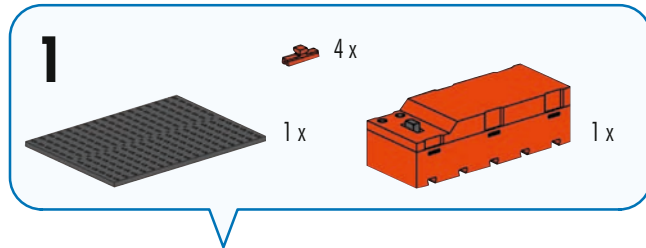
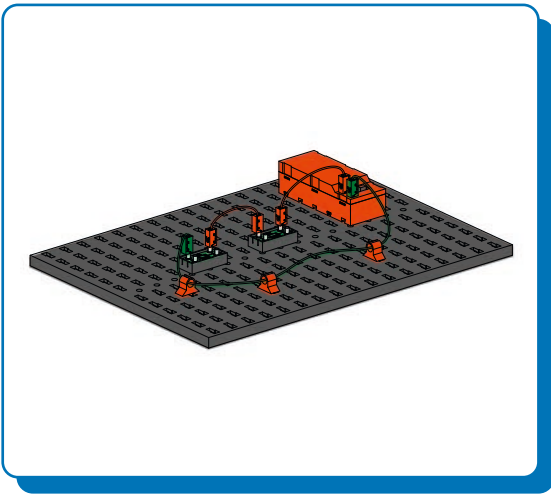

Circuito de resistencias en serie
Conexão da Série de Resistência
Resistenze in serie

Последовательное
соединение
сопротивлений
光束刻度

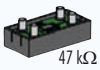

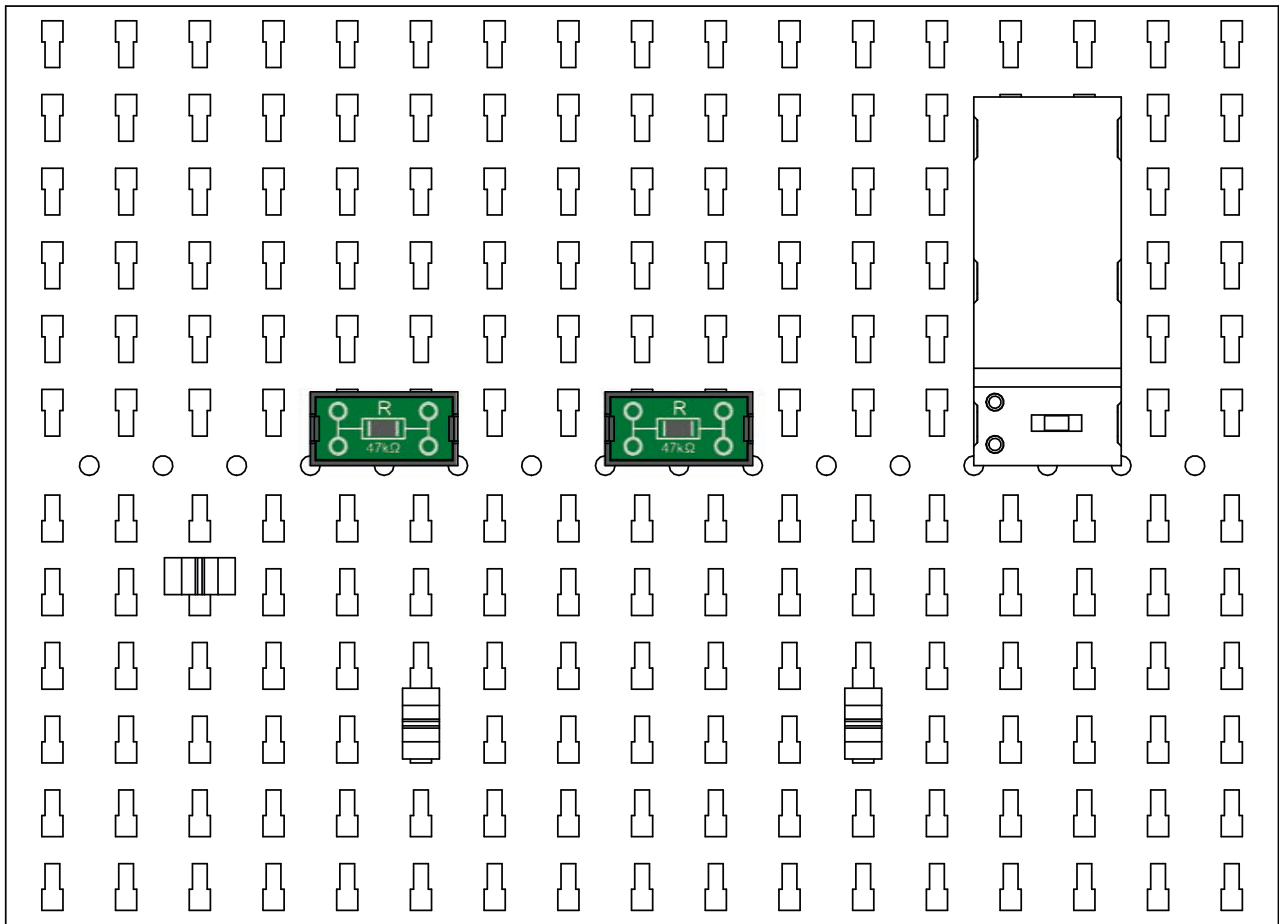
3  2 x
47kΩ



4  1 x - 30 cm  2 x - 10 cm

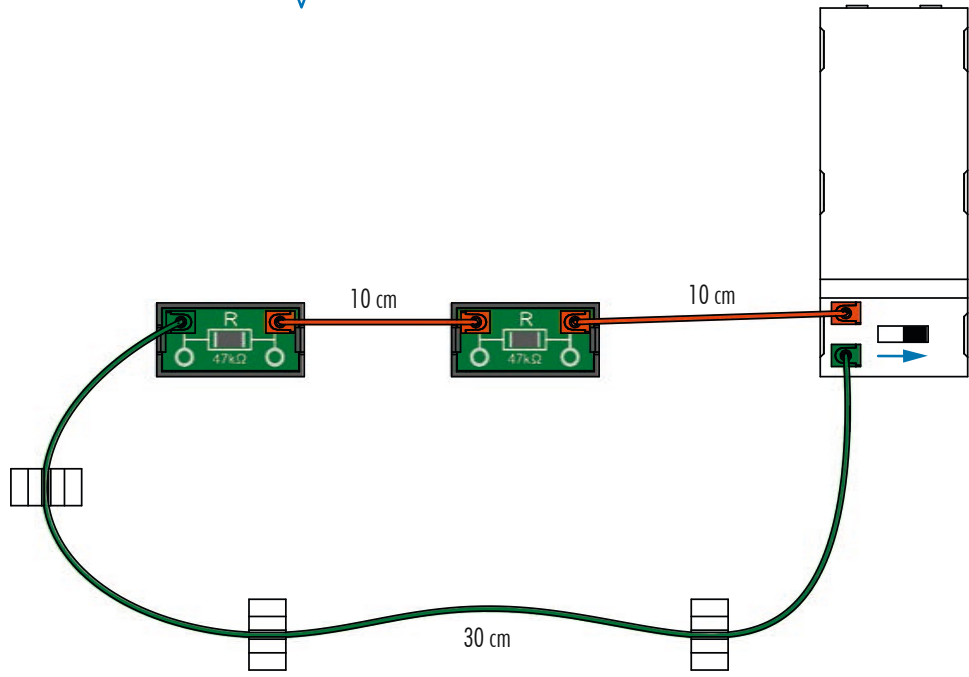

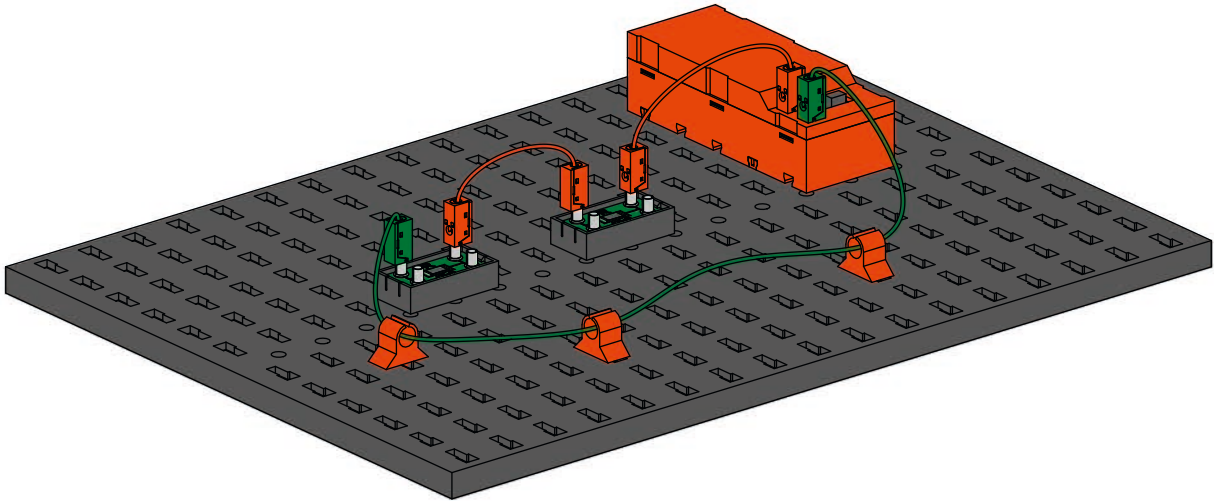



Widerstand Parallelschaltung
Resistance parallel connection
Résistance connexion parallèle
Weerstand parallelaansluiting

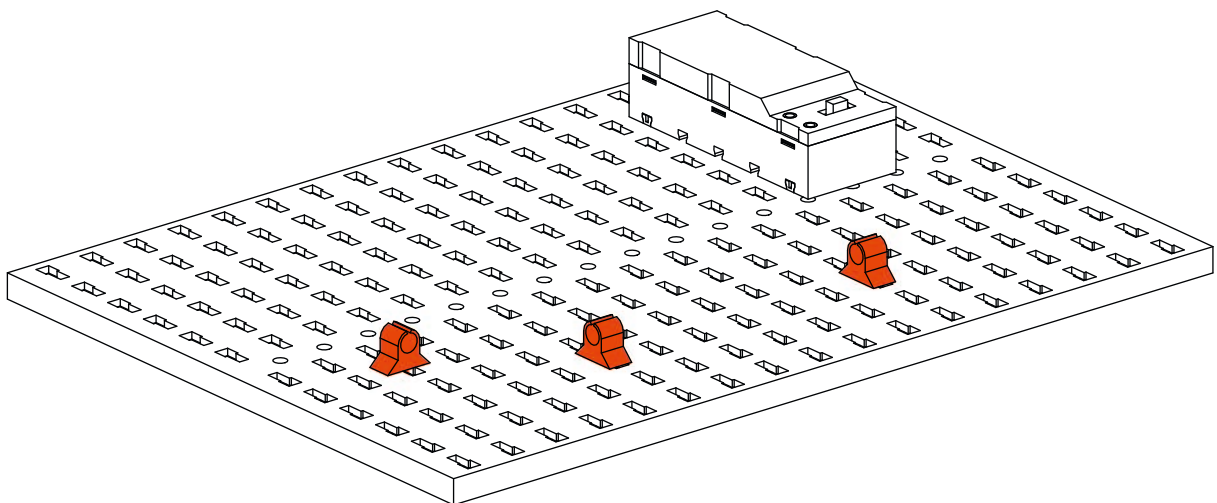
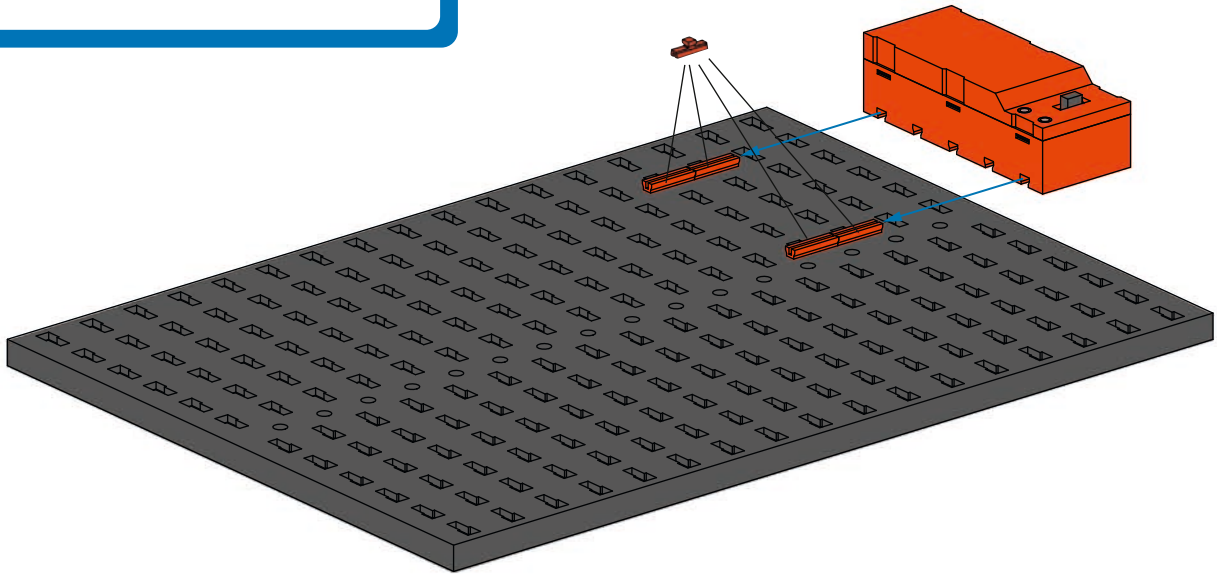
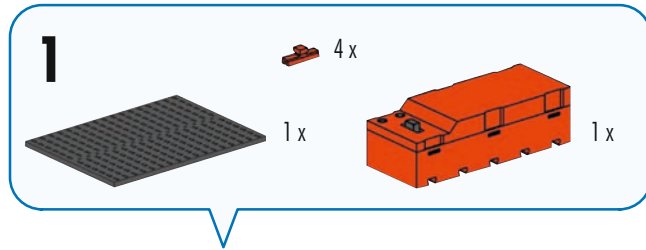
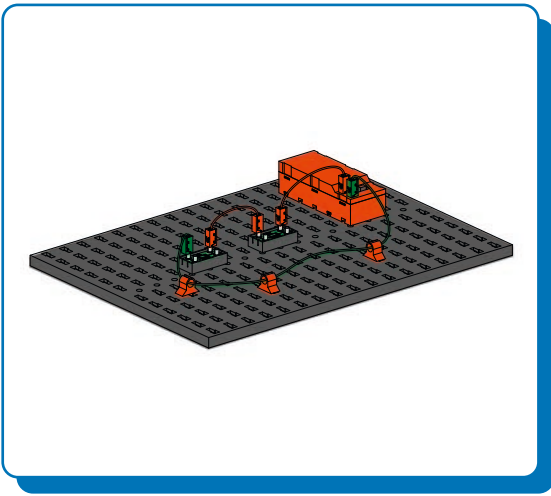

Circuito de resistências em paralelo
Resistência Conexão paralela
Resistenze in parallelo

Параллельное соединение сопротивлений
电阻 平行连接

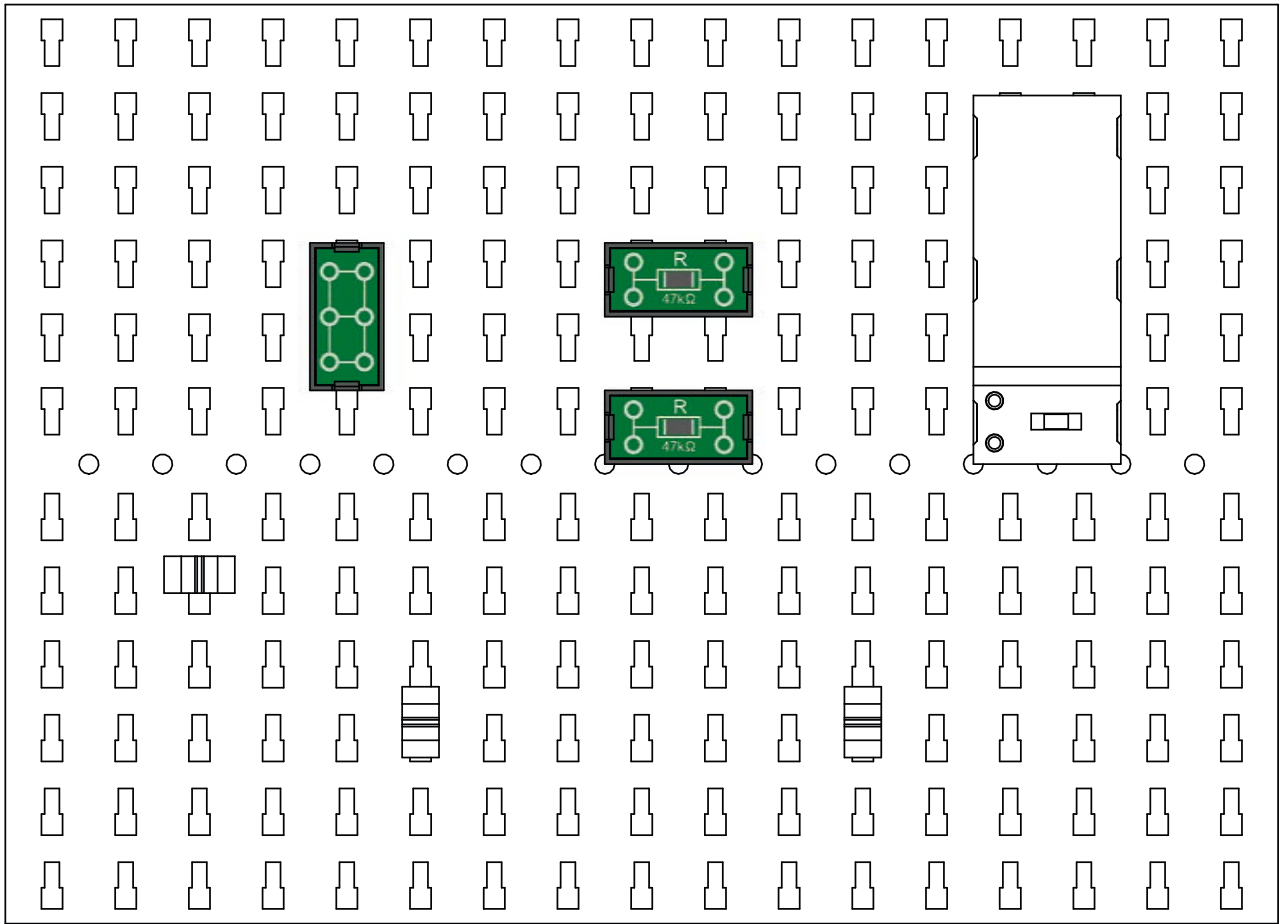

3  2 x  1 x

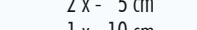

4  1 x - 30 cm  2 x - 5 cm
 1 x - 10 cm

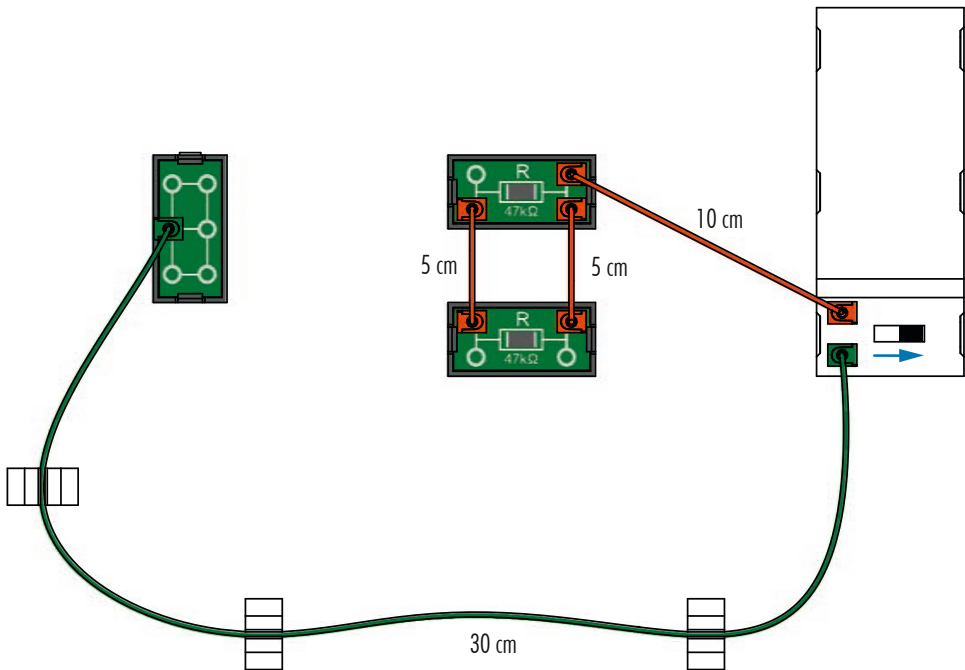

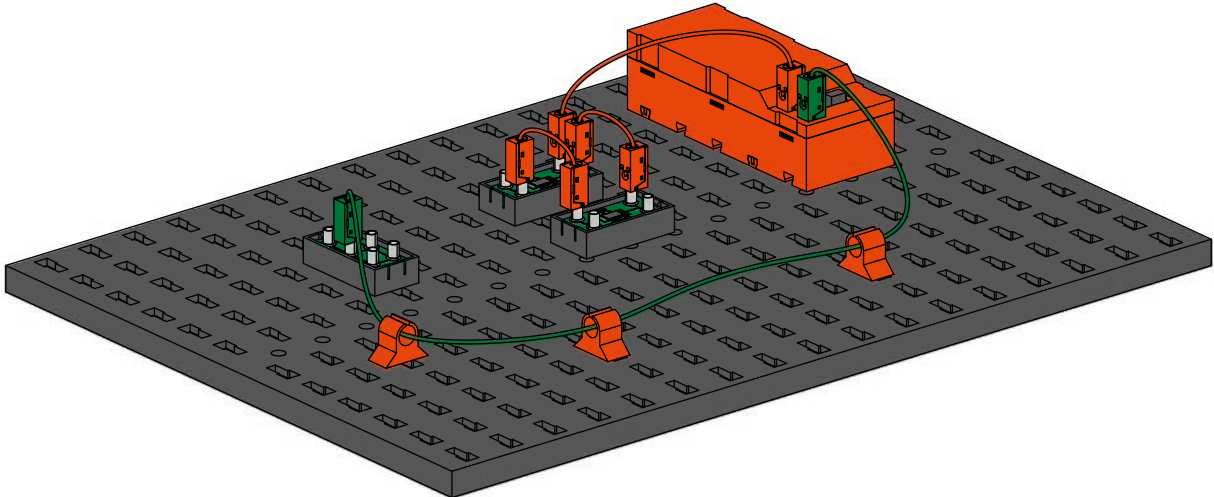



Diode
Diode
Diode

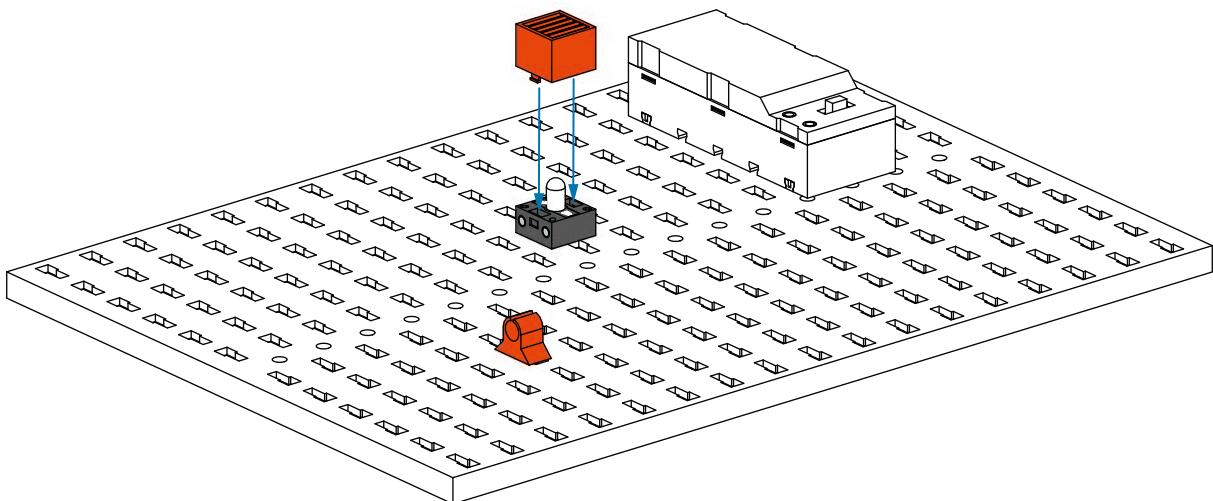
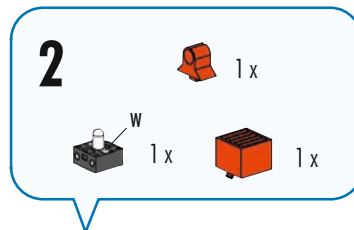
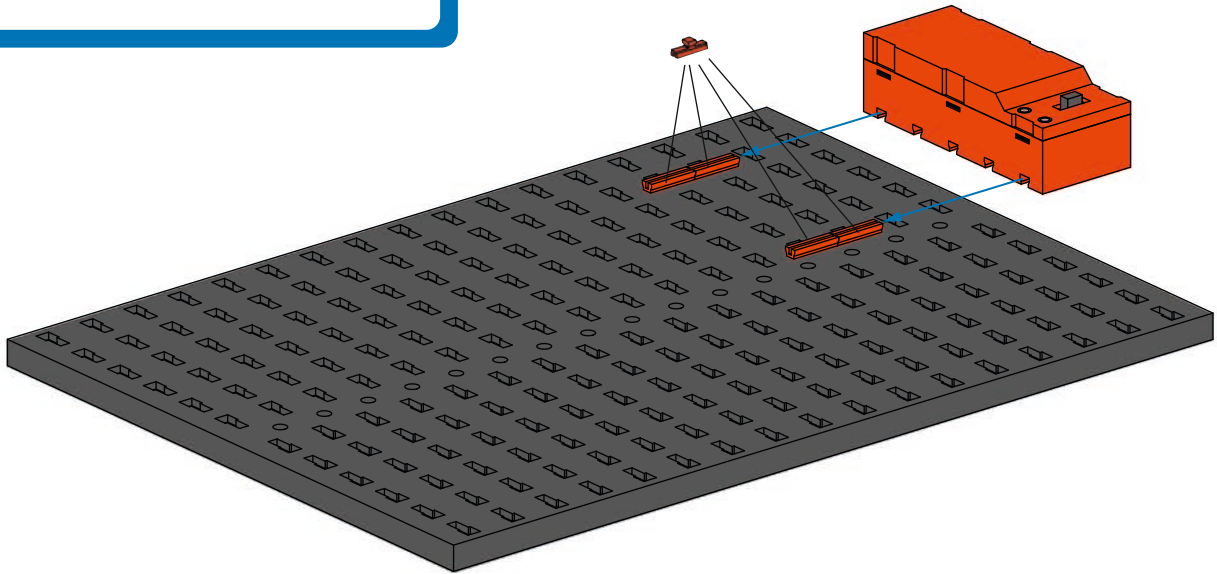
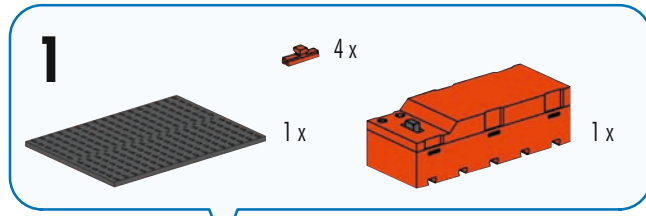
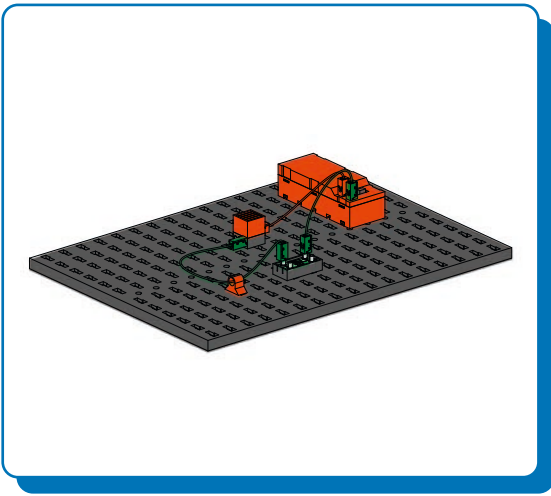

Diode
Diode
Diode

Diode
Диод
二极管



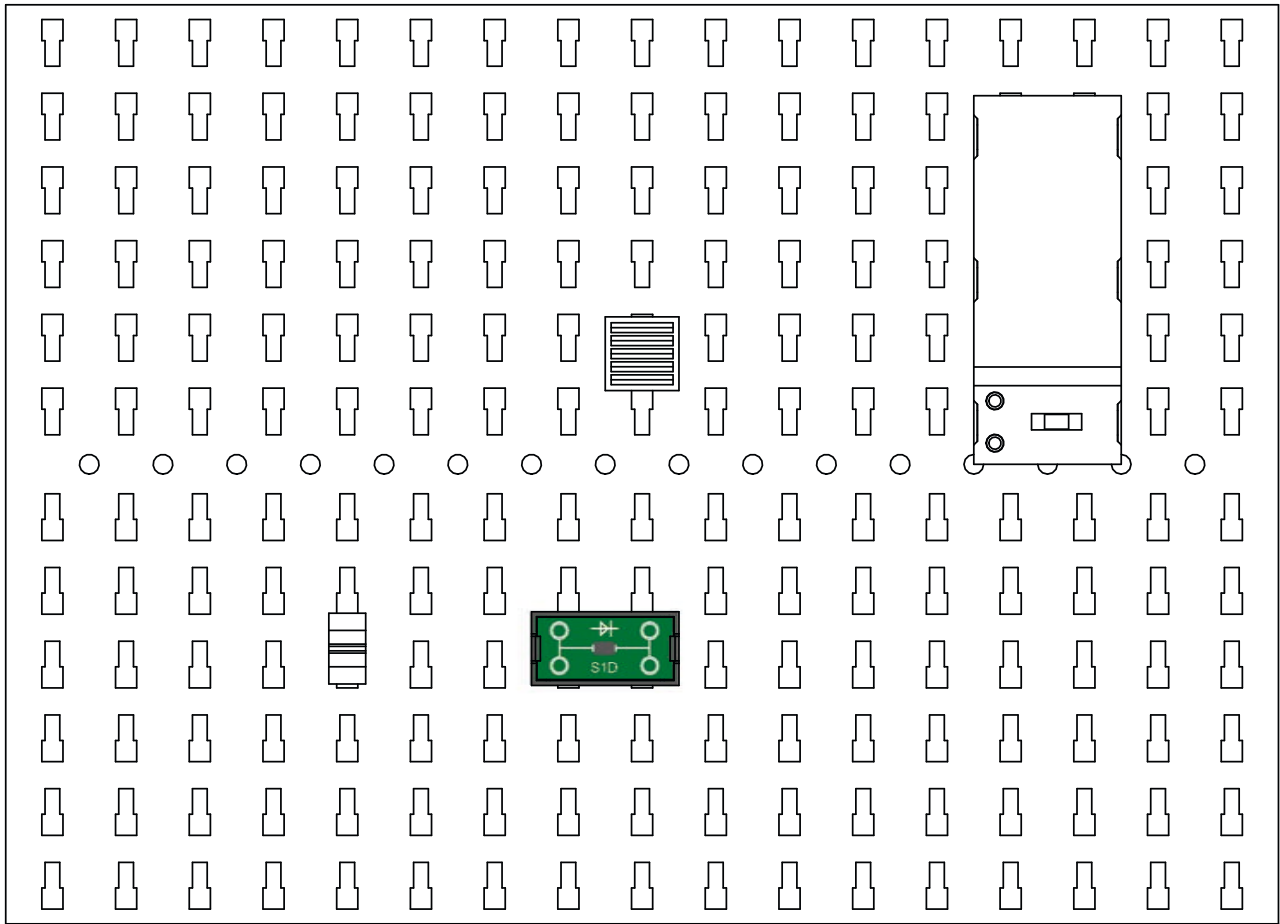

3  1 x
S1D

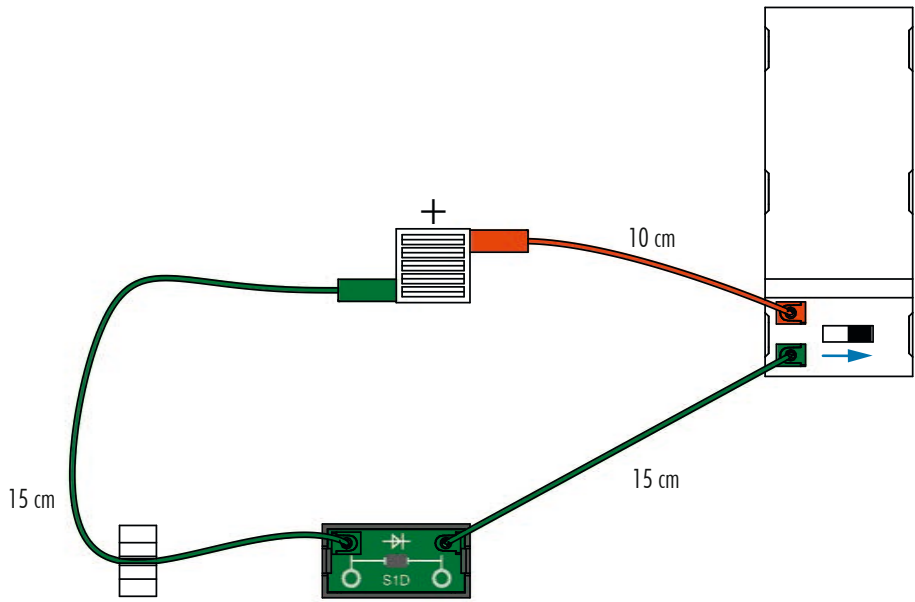

4  2 x - 15 cm  1 x - 10 cm

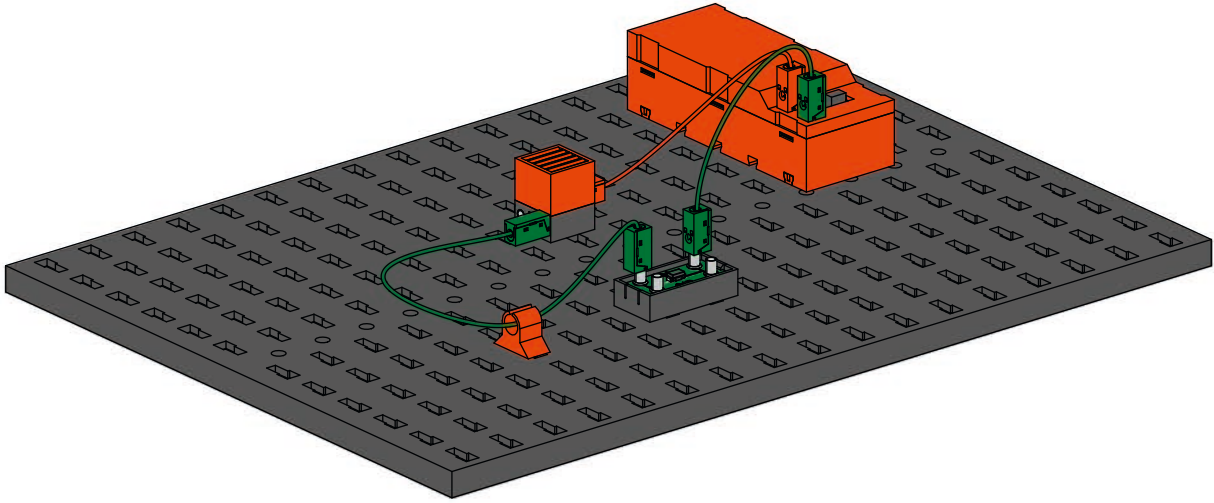

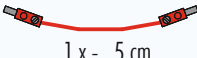

5  1x  1x  1x - 5 cm

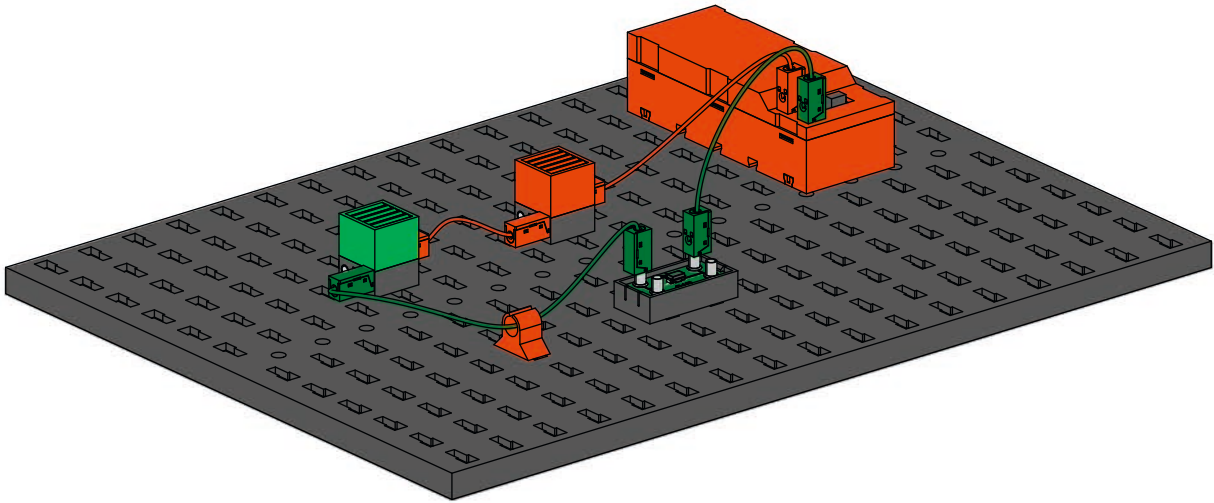
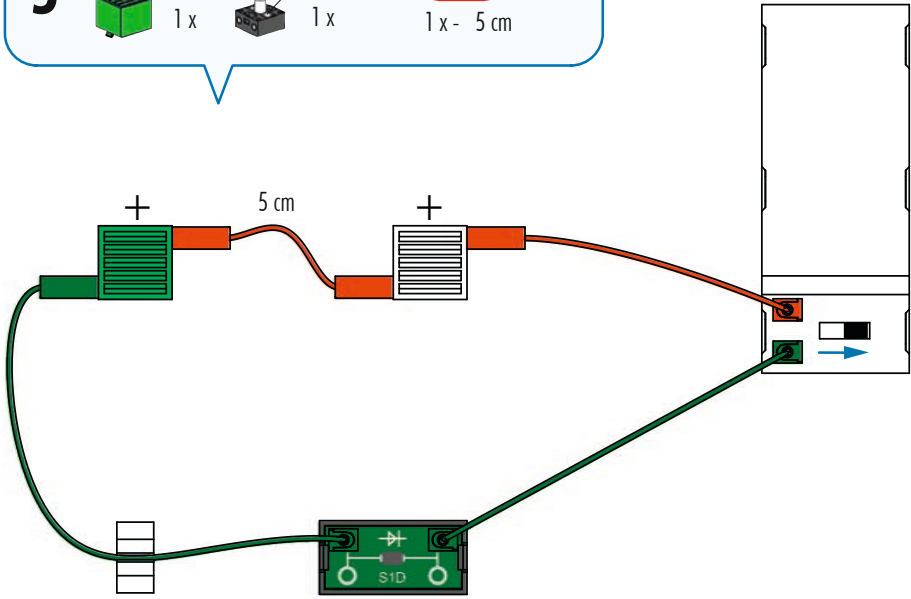

Diode Kennlinie
Diode characteristic
Caractéristique de la diode

Diode karakteristiek
Característica del diodo
Característica do Diodo

Caratteristica del diodo
Характеристика
диода
二极管特性

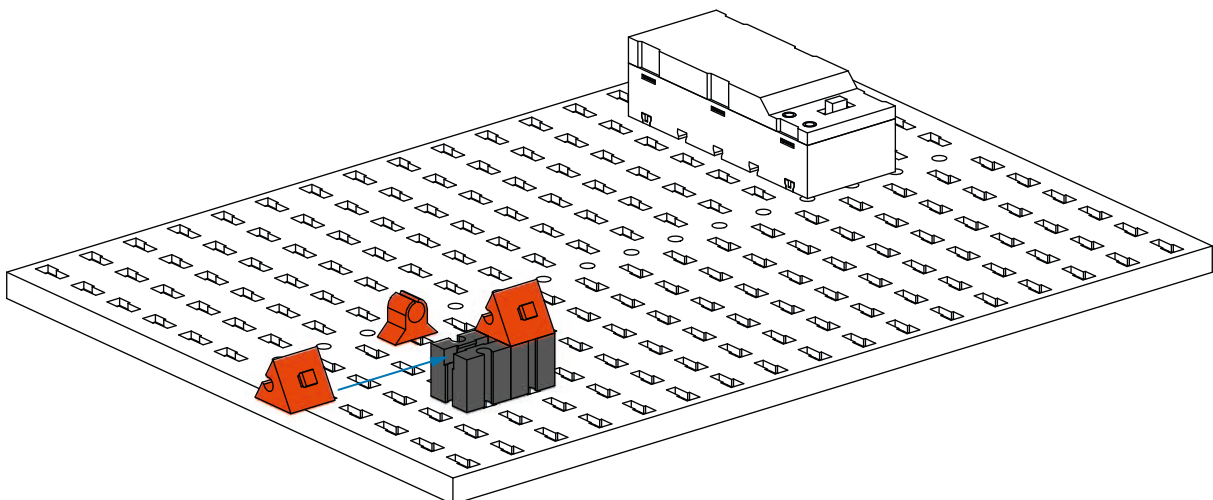
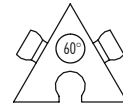
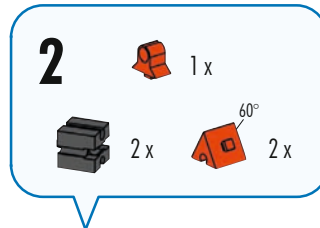
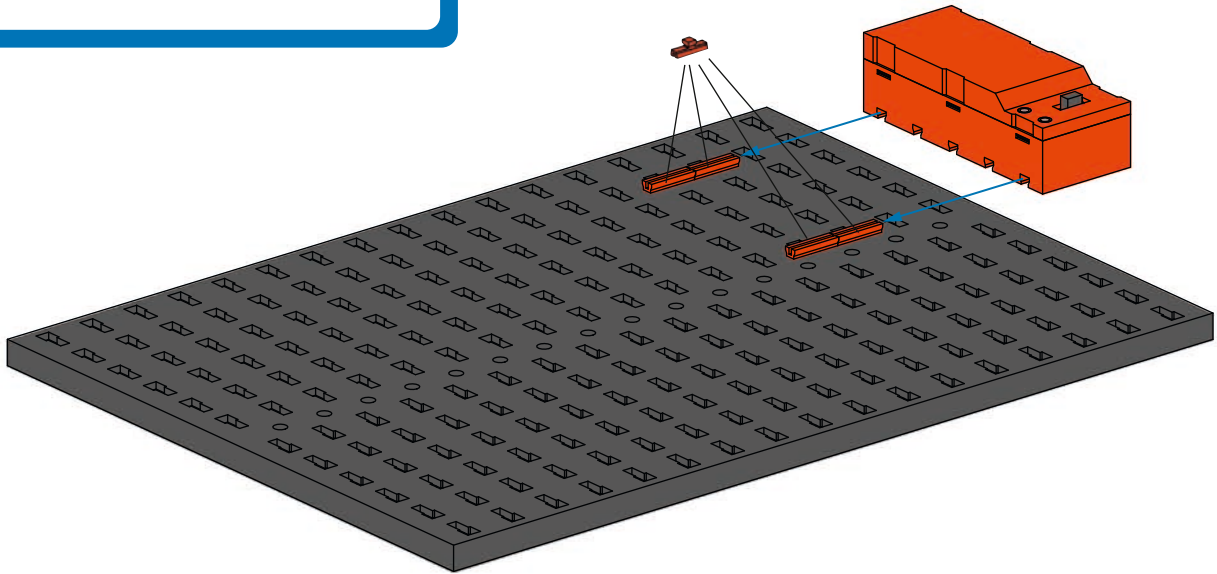
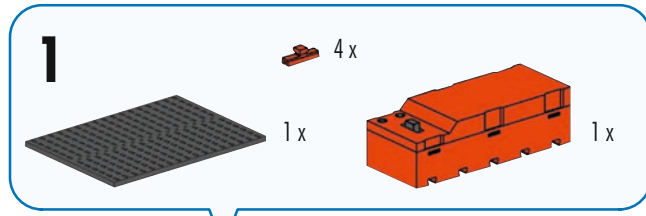
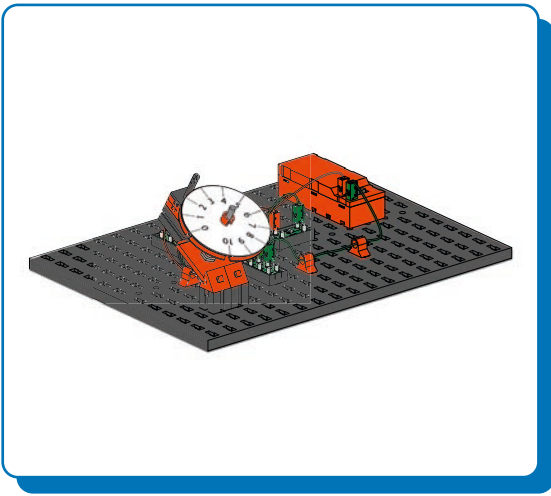

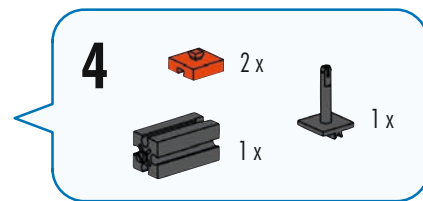
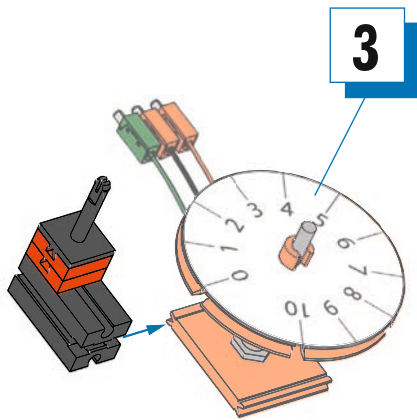
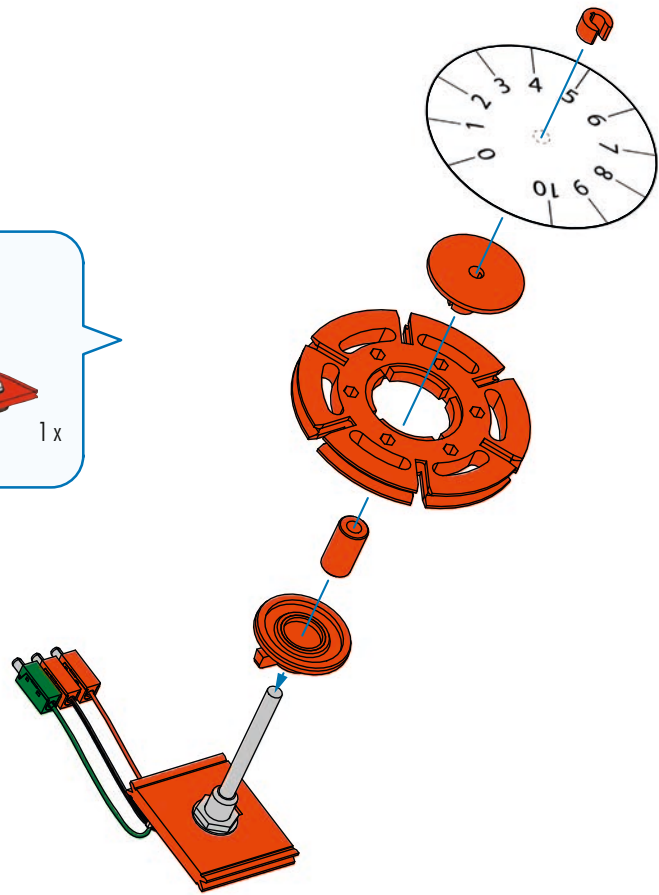
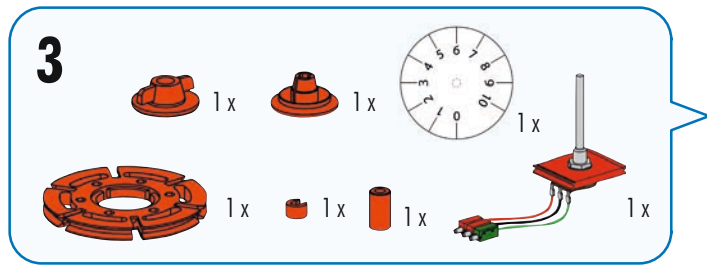

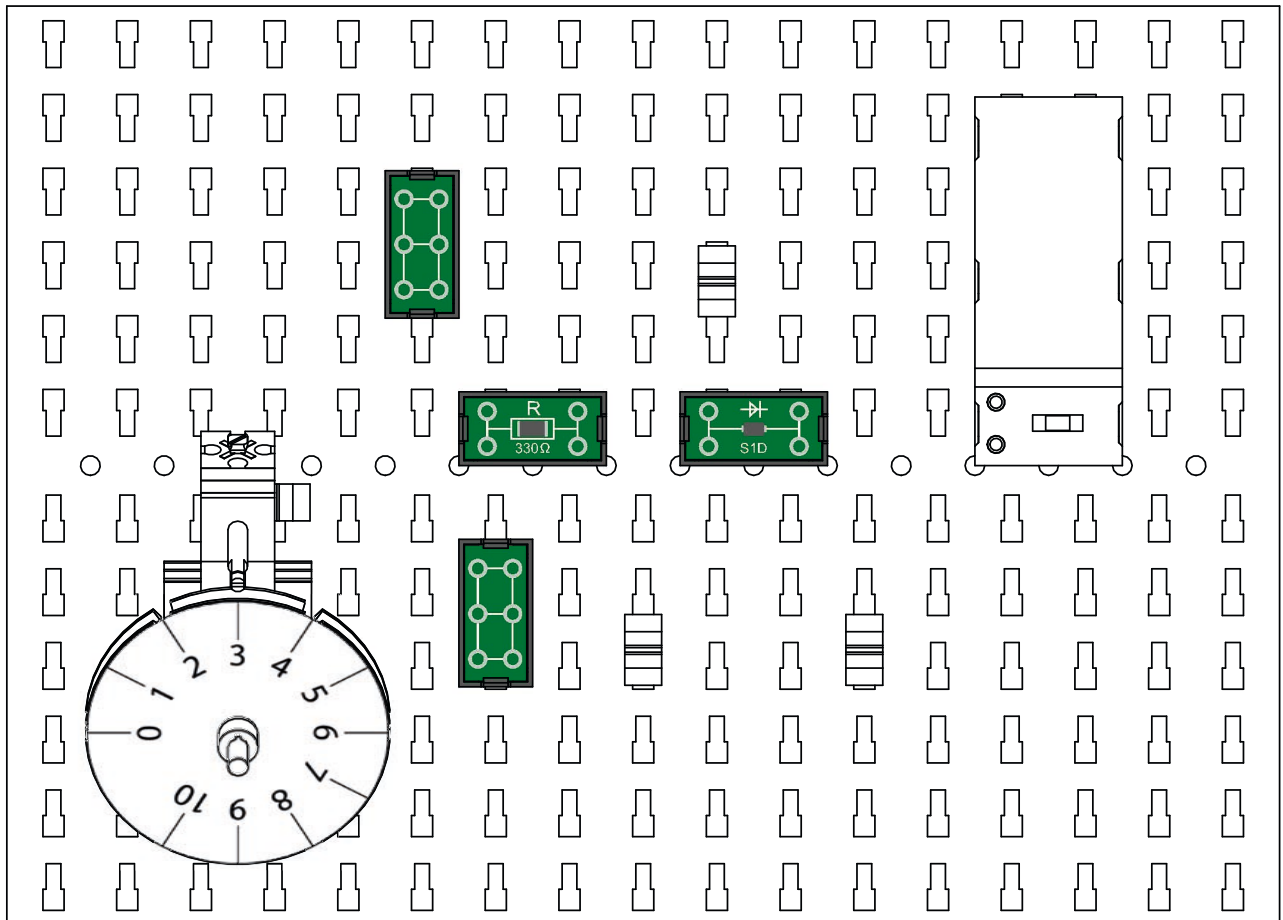
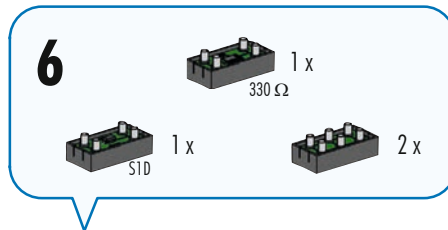
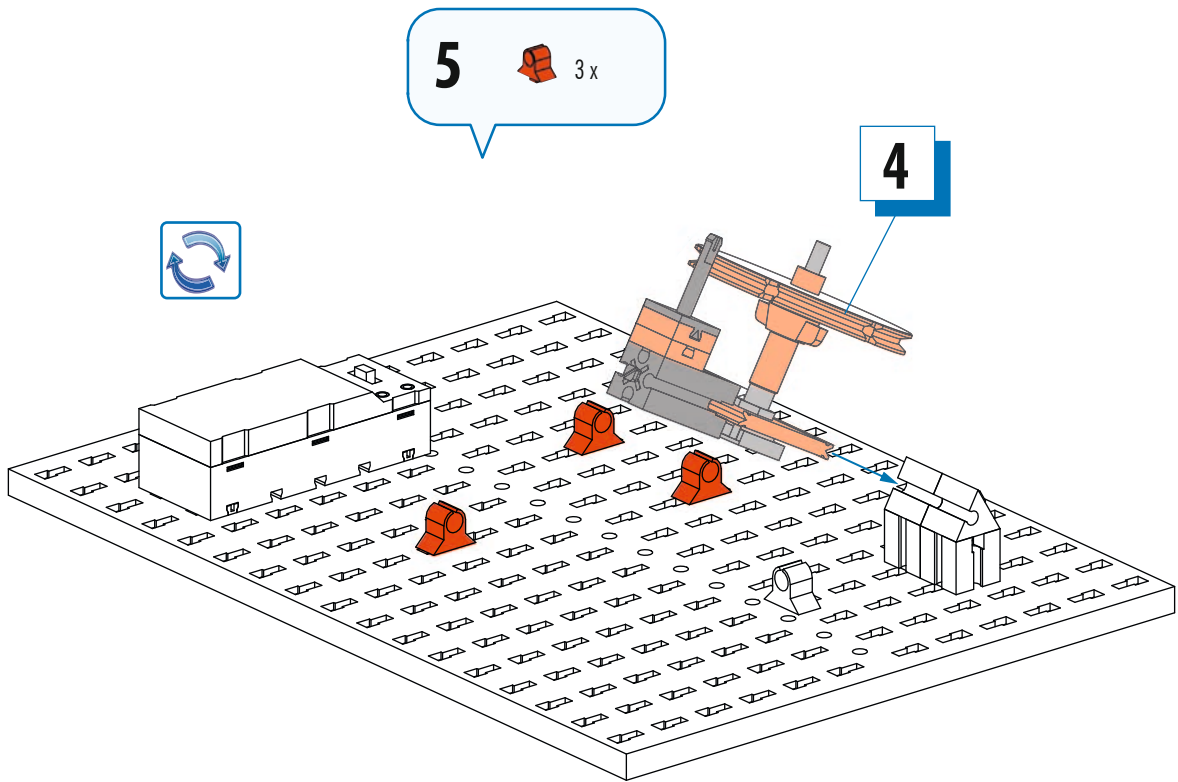



Transistor
Transistor
Transistor

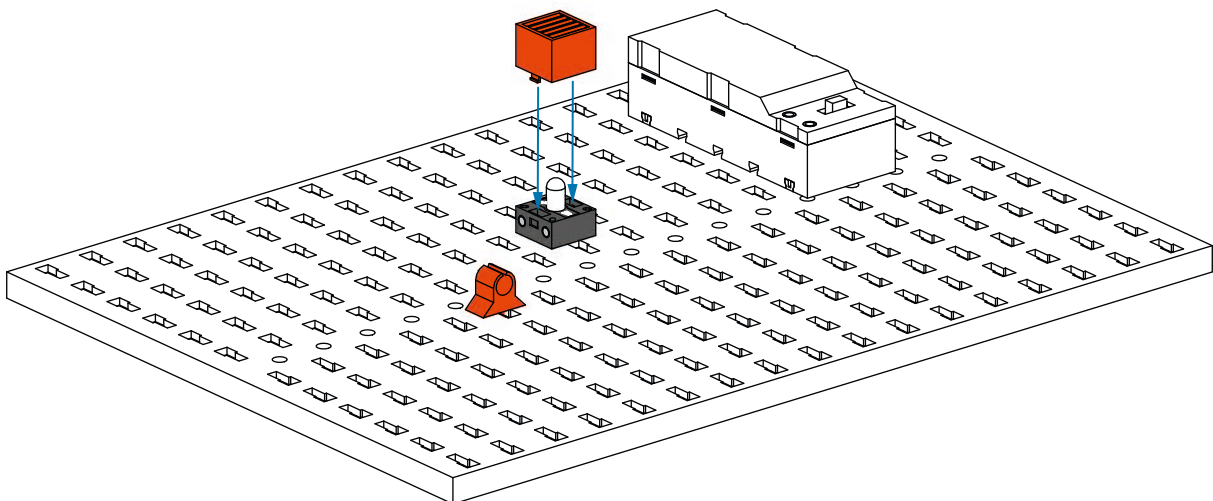
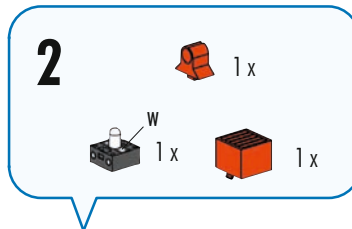
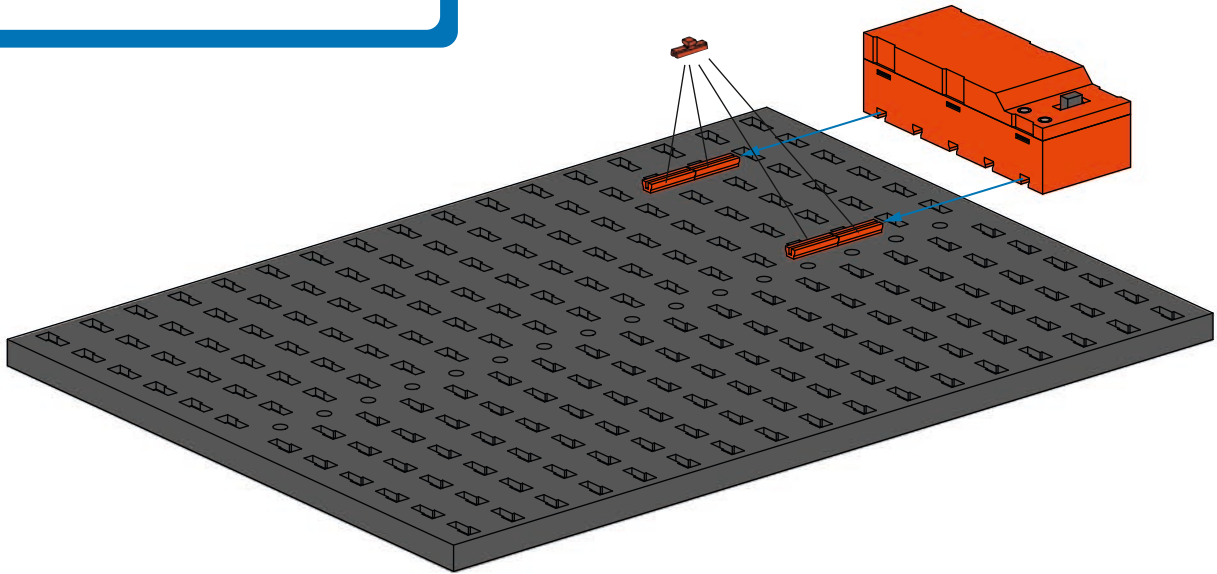
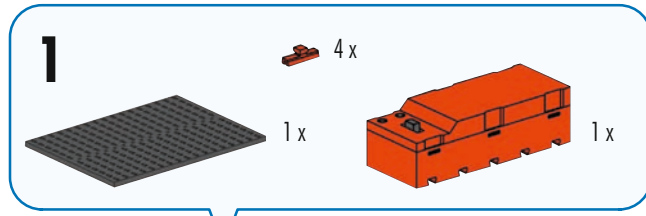
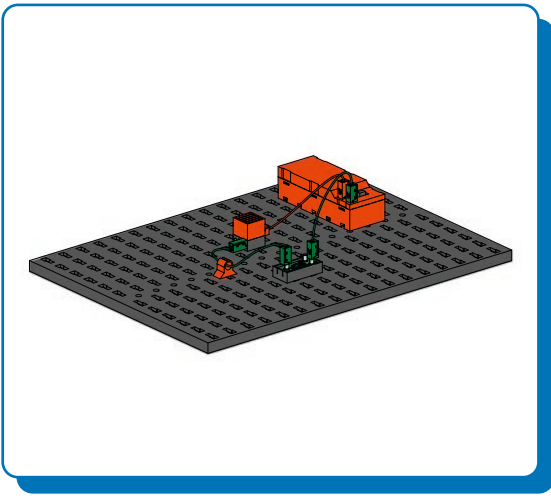

Transistor
Transistor
Transistor

Transistor
Транзистор
晶体管

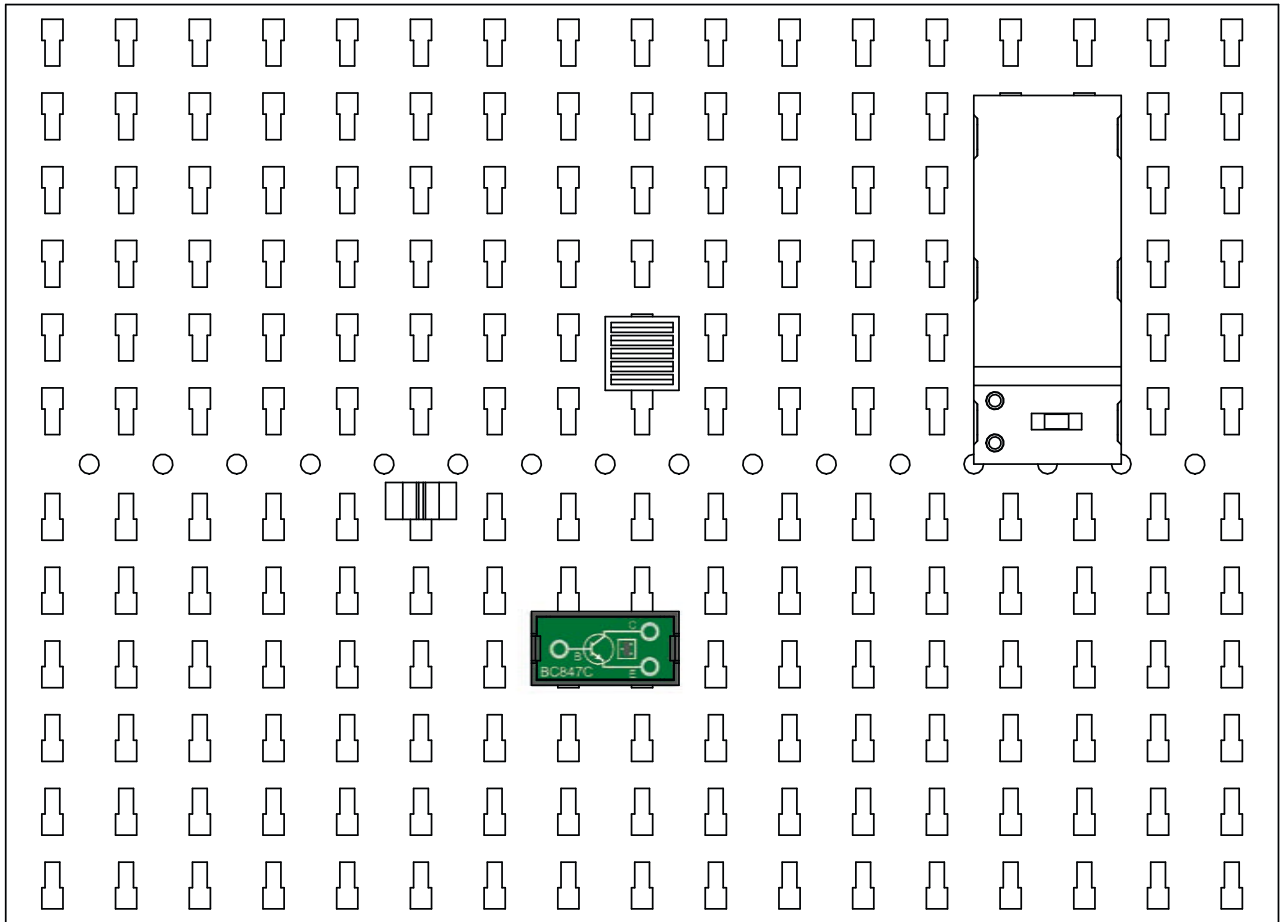

3  1 x
BC847C



4  2 x - 15 cm  1 x - 10 cm

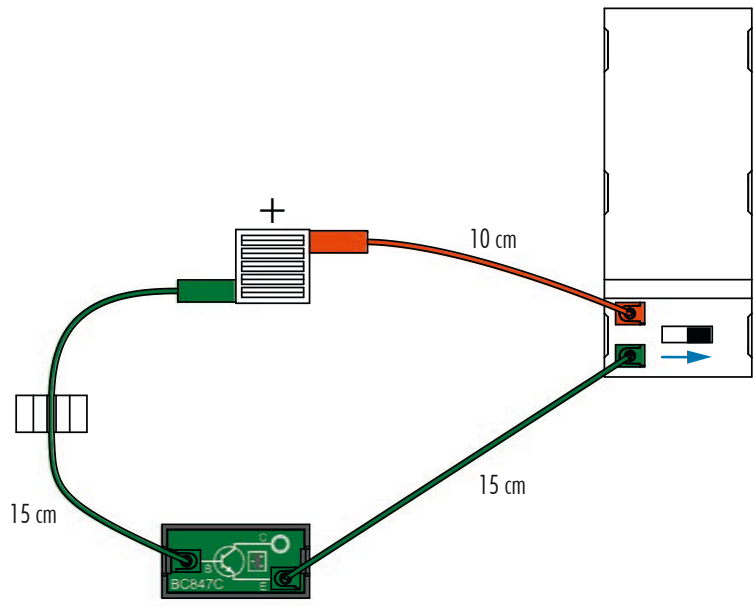

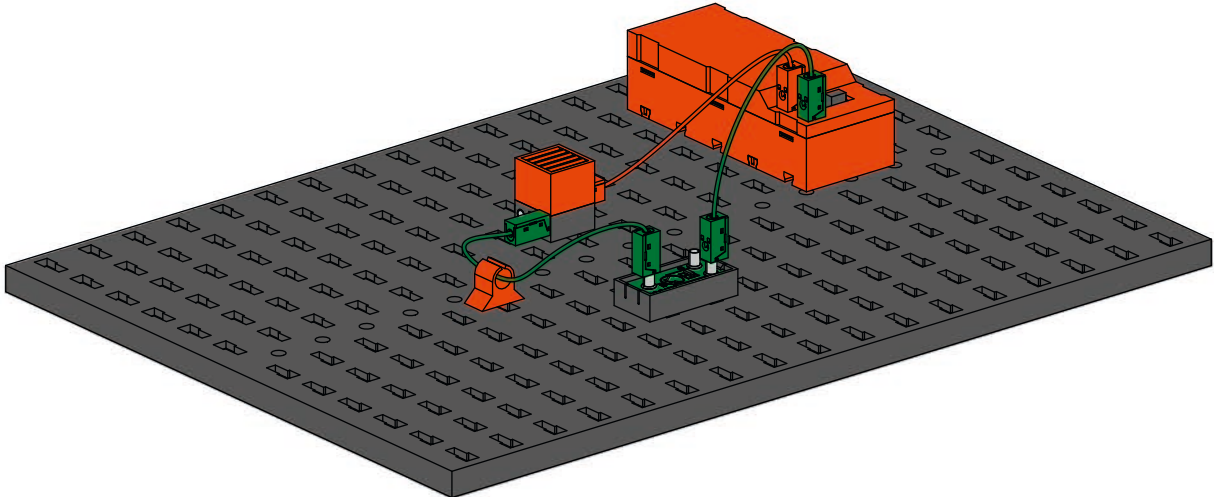

Transistor einfache Schaltung
 Transistor - simple circuit
 Transistor - Circuit simple
 Transistor - eenvoudige schakeling

Transistor - circuito simple
 Transistor - comutação simples
 Transistor - circuito semplice

Транзистор - простая
 схема подключения
 晶体管 - 简单电路

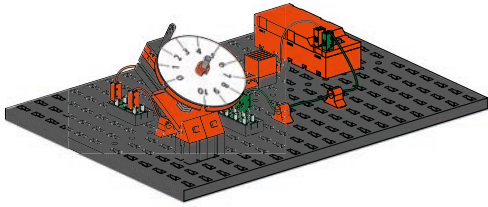

1-4

Seite 24
 Page 24
 Page 24
 Bladzijde 24
 Página 24
 Pagina 24
 Pagina 24
 Страница 24
 页次 24

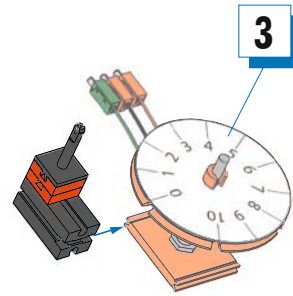

5



2 x







1 x



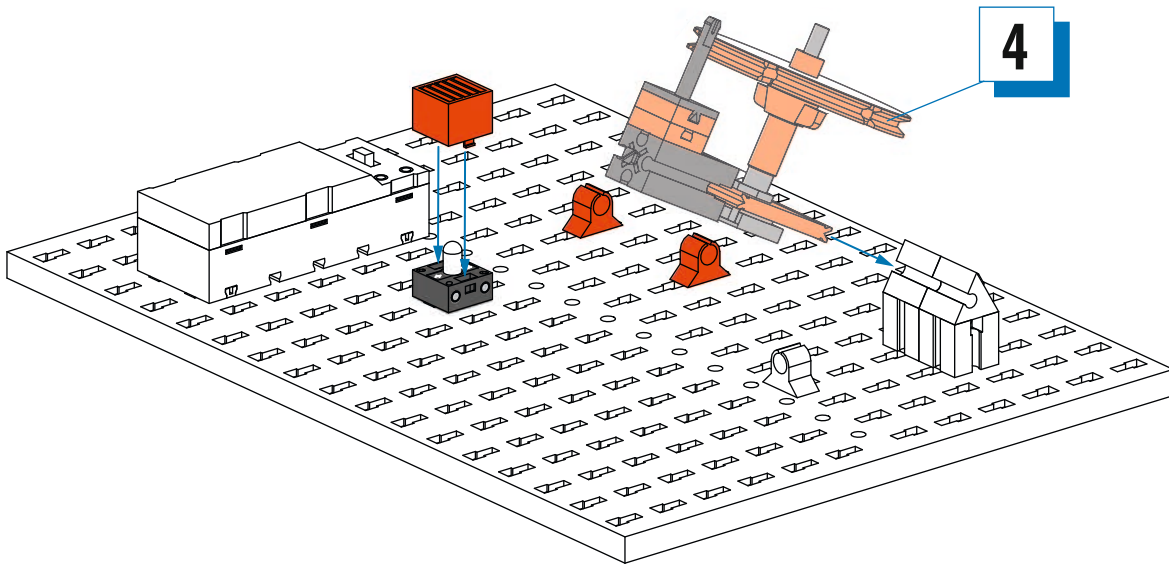

1 x

4

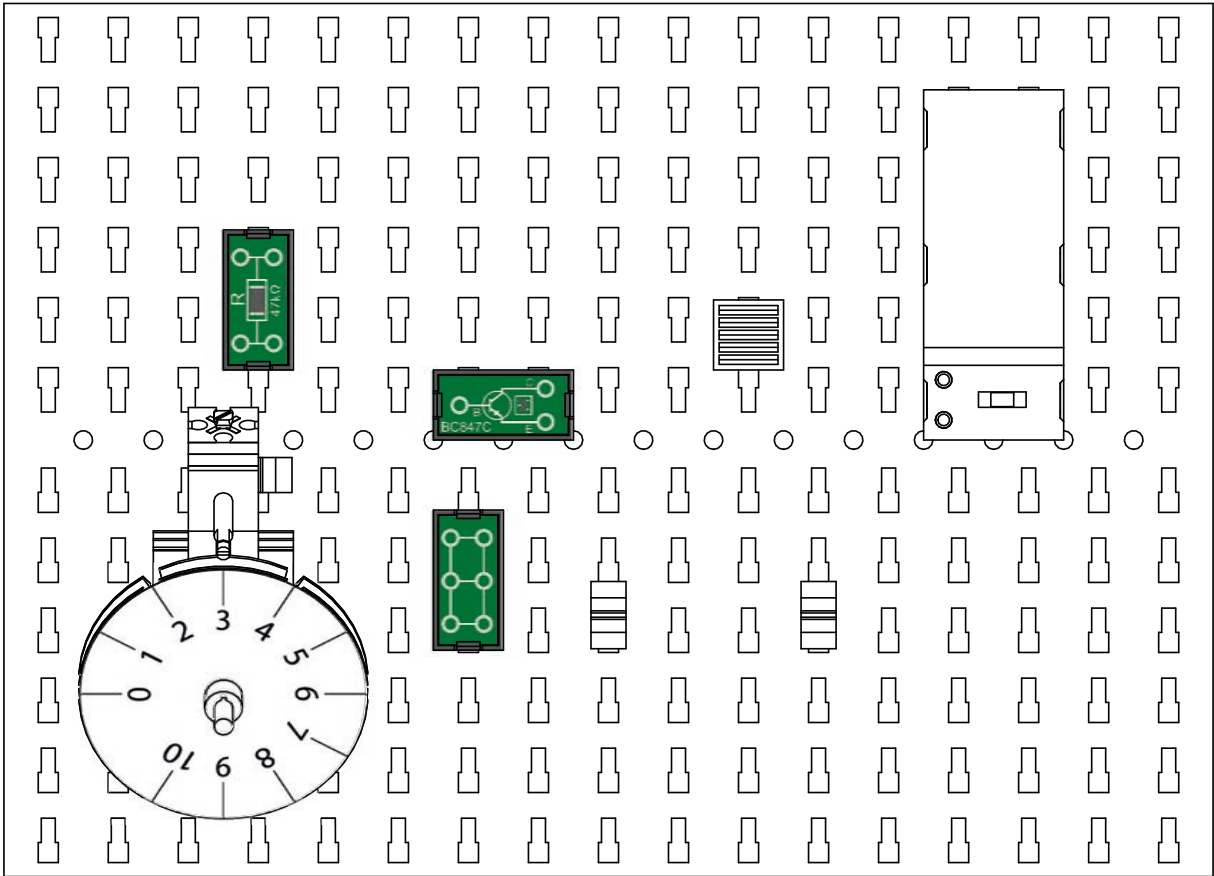

- 6**  1x  1x  1x



- 7**  1x - 10 cm
1x - 20 cm  2x - 10 cm
1x - 15 cm

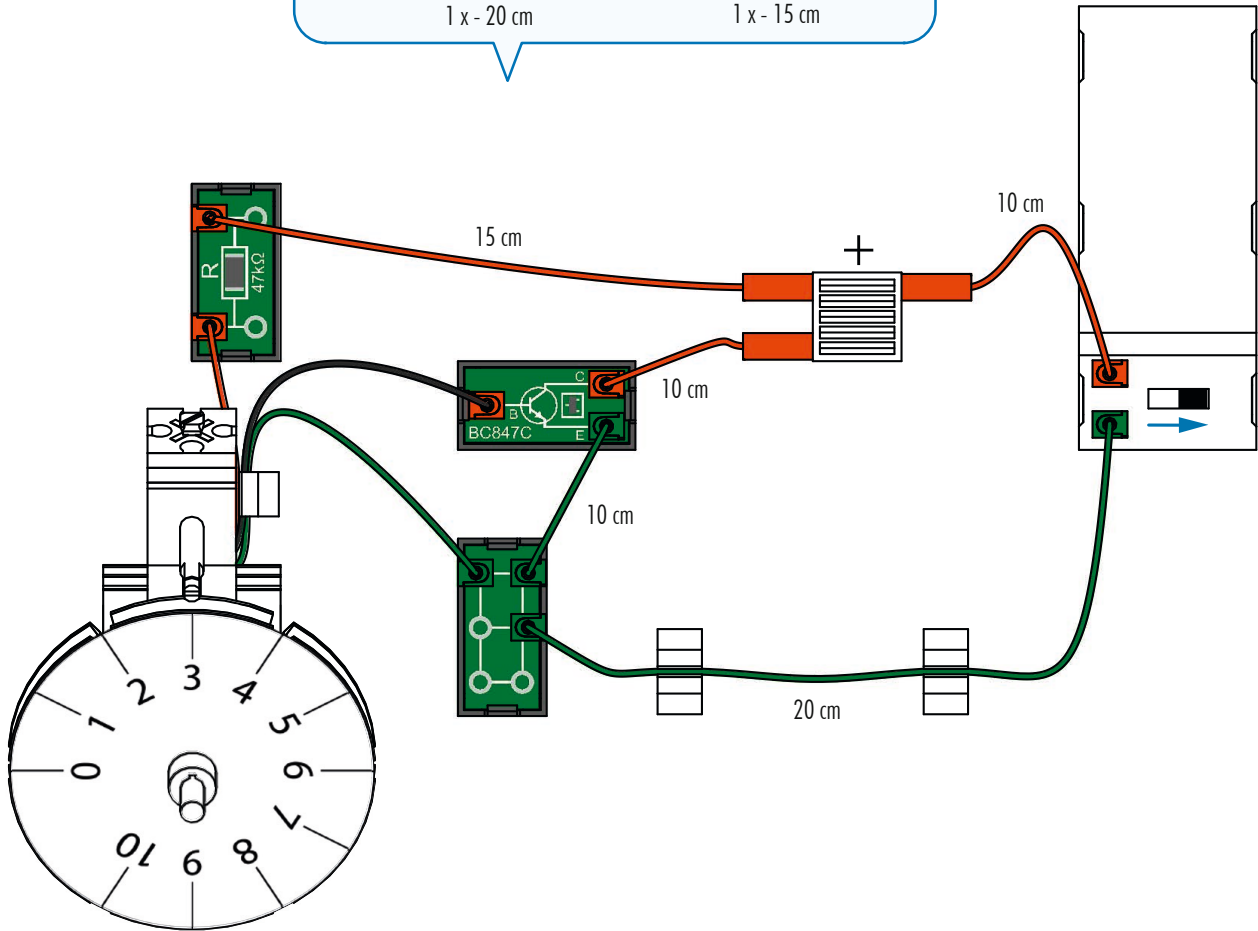

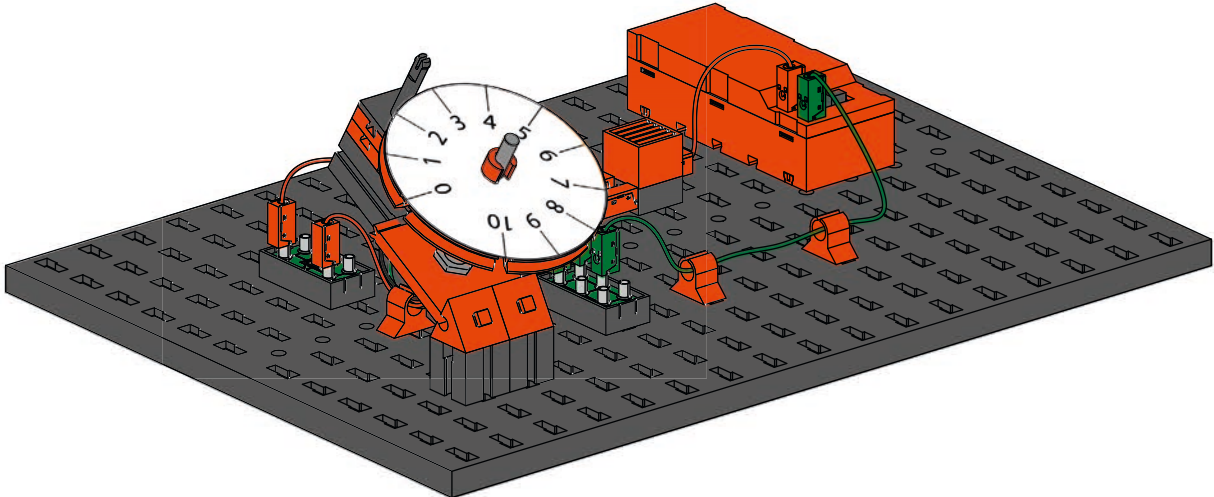

Transistorkennlinie
 Transistor characteristic
 Caractéristique du transistor

Transistorkarakteristiek
 Característica del transistor
 Característica do transistor

Caratteristica del transistor
 Характеристика
 транзистора
 晶体管特性

1-4

Seite 24
 Page 24
 Page 24
 Bladzijde 24
 Página 24
 Pagina 24
 Pagina 24
 Страница 24
 页次 24

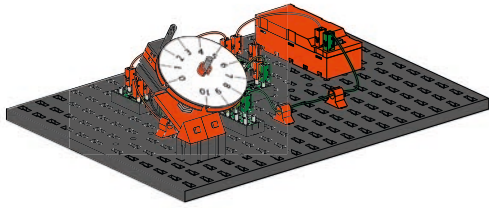

3

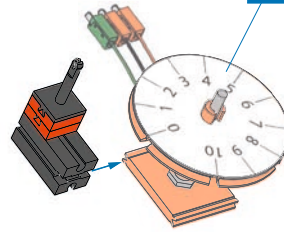

5  2x

4

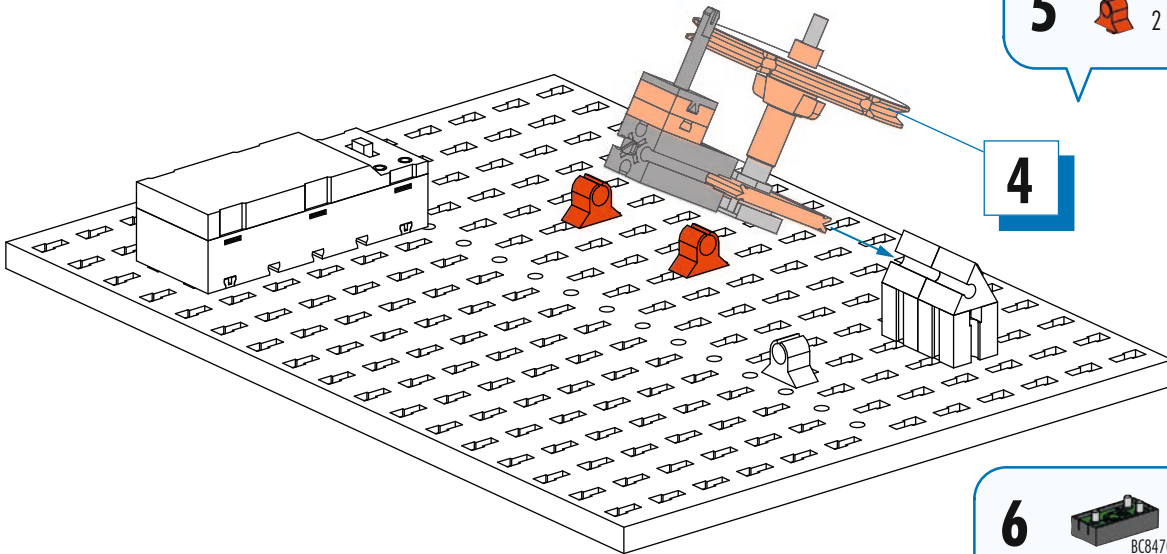

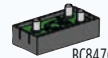
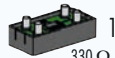
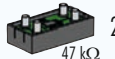
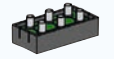
6  1x  1x
 2x  1x

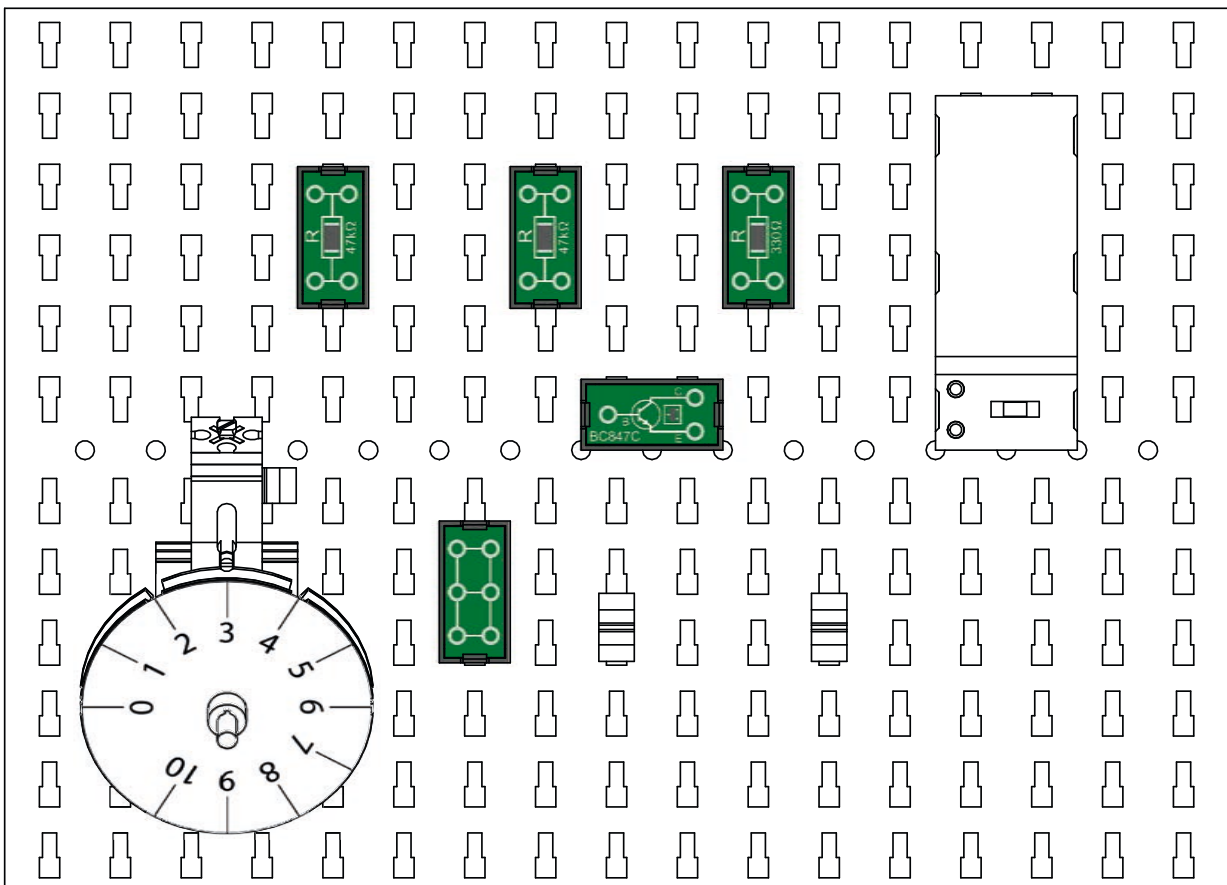

- 7**
- 1 x - 10 cm
 - 1 x - 20 cm
 - 5 x - 10 cm

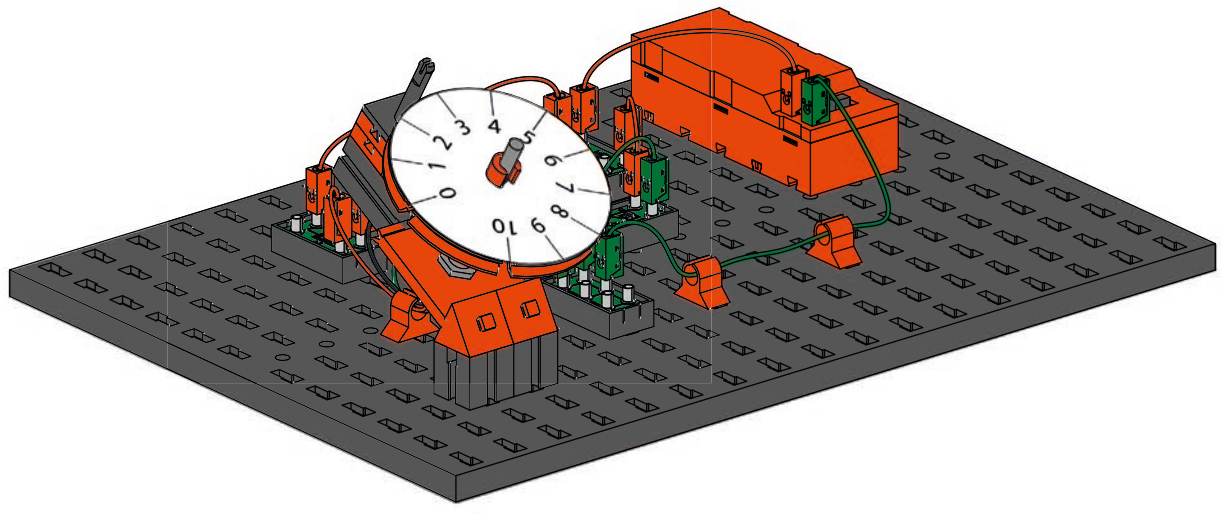
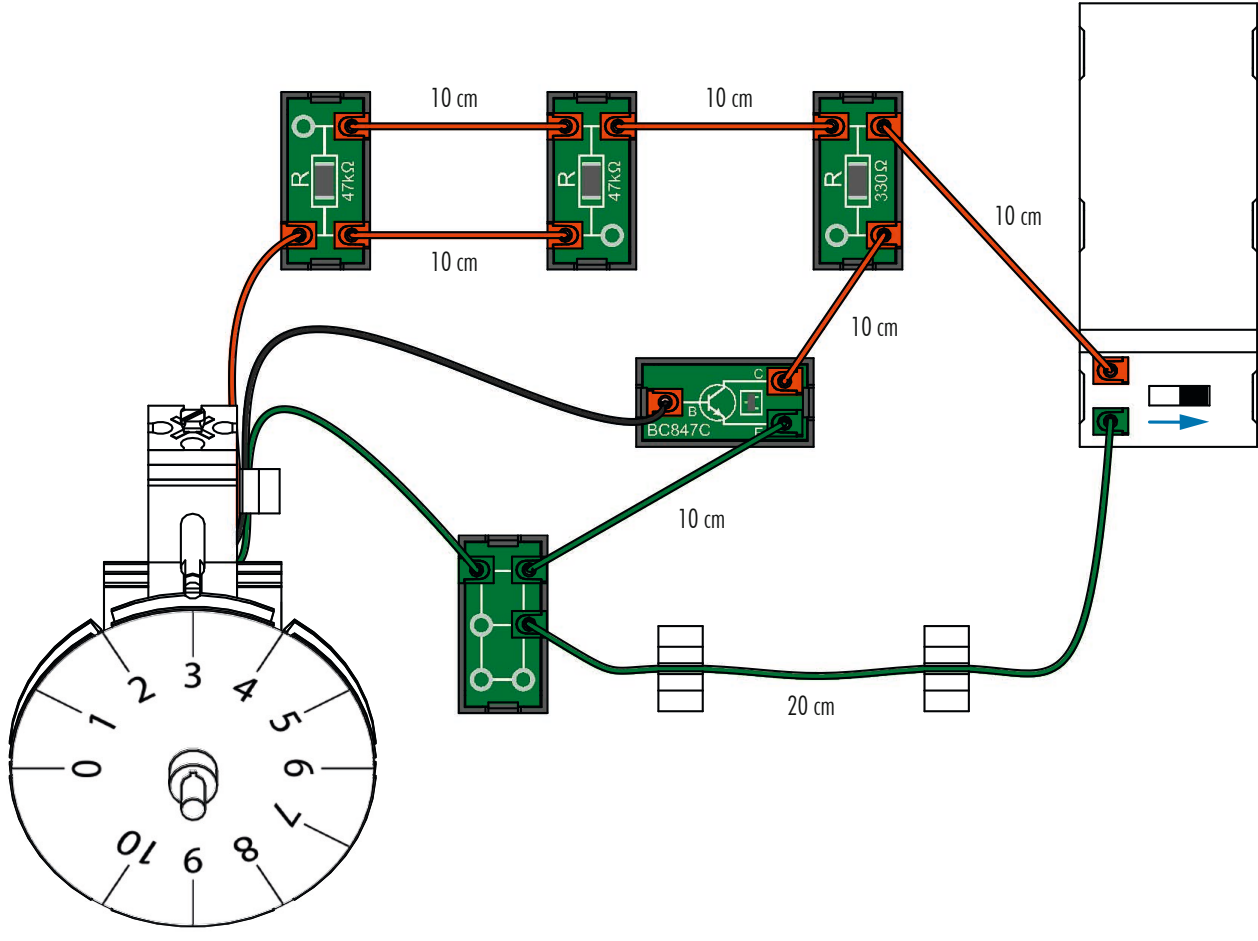

Darlingtonschaltung
Darlington circuit
Circuit Darlington

Darlingtontransistor
Transistor Darlington
Circuito de Darlington

Circuito Darlington
Схема Дарлингтона
达林顿电路

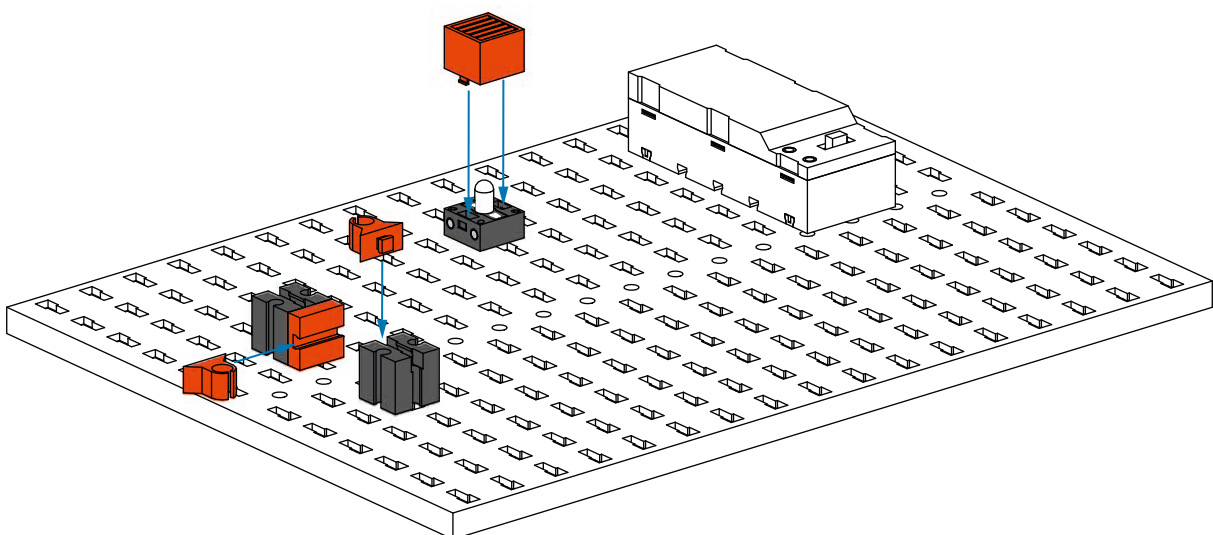
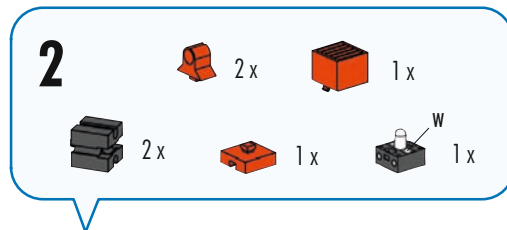
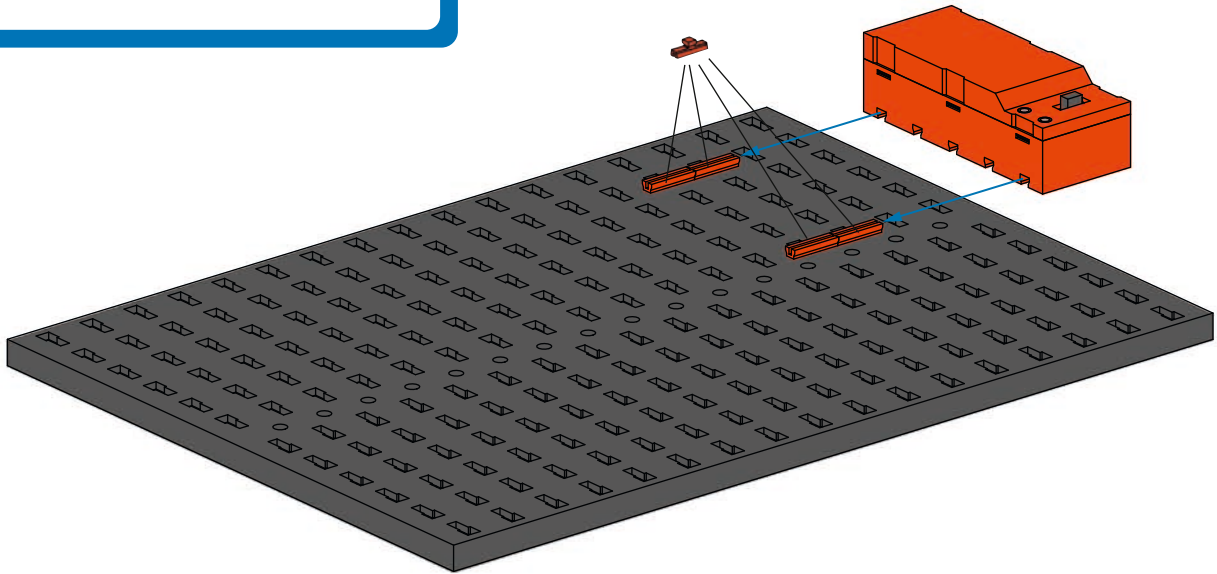
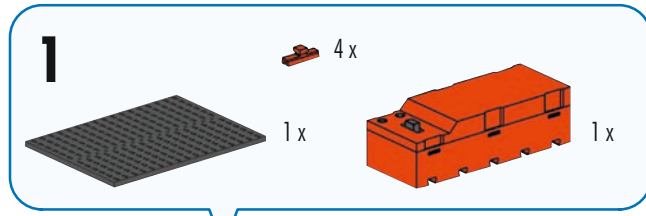
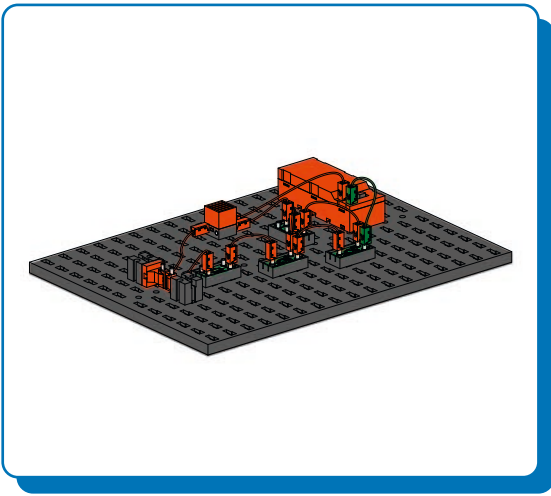

3

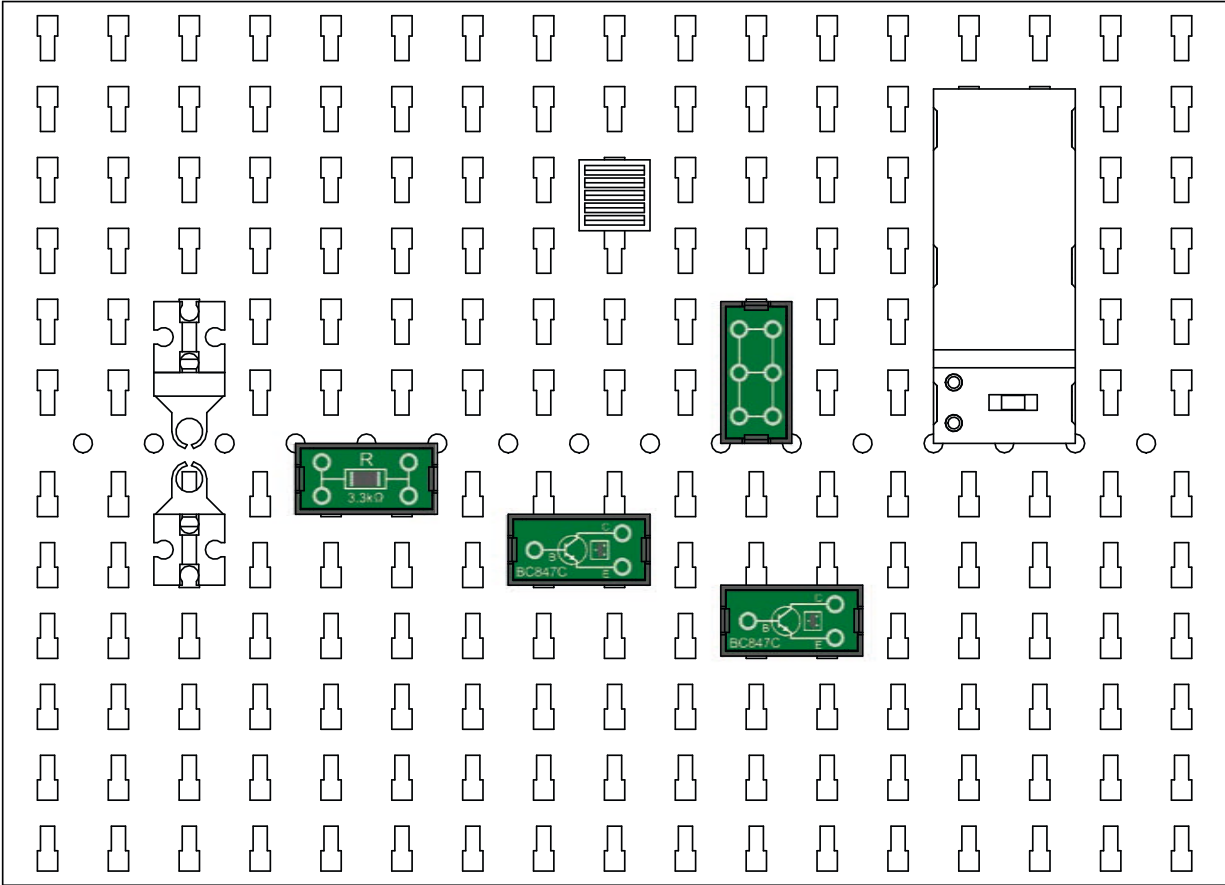
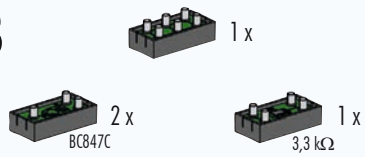

4

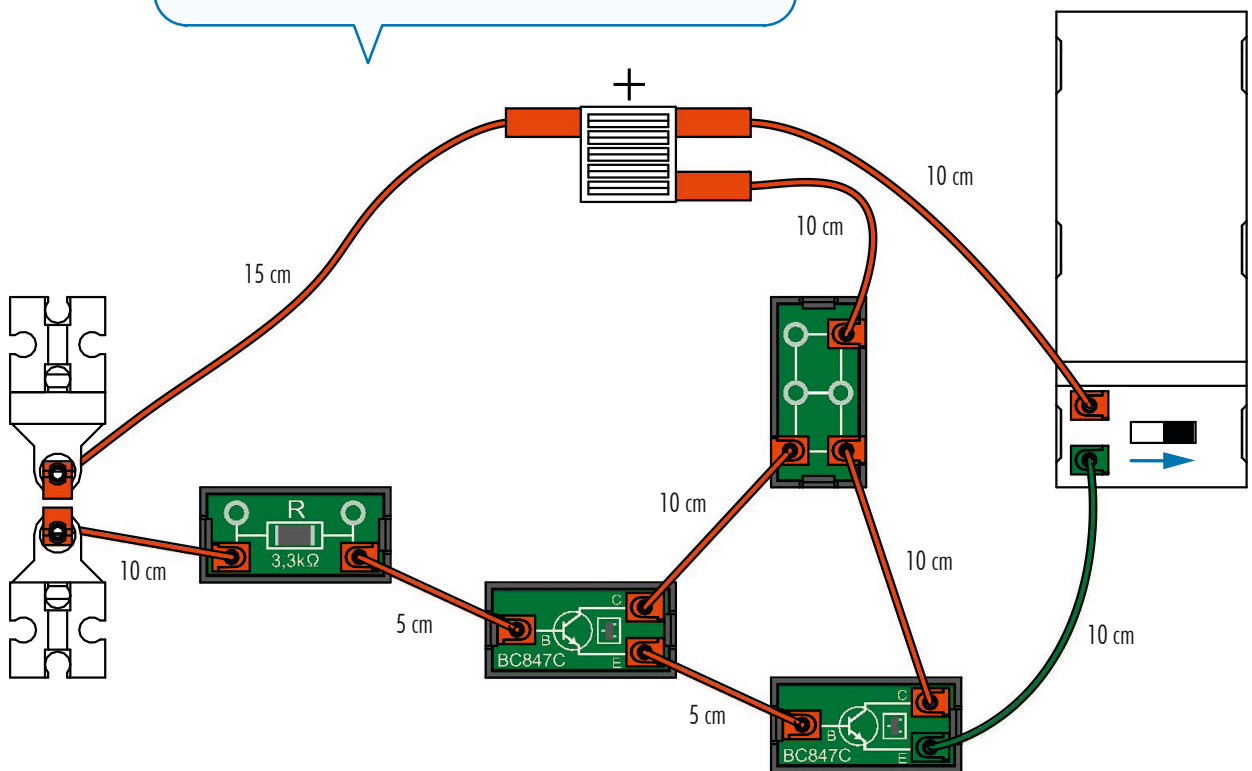

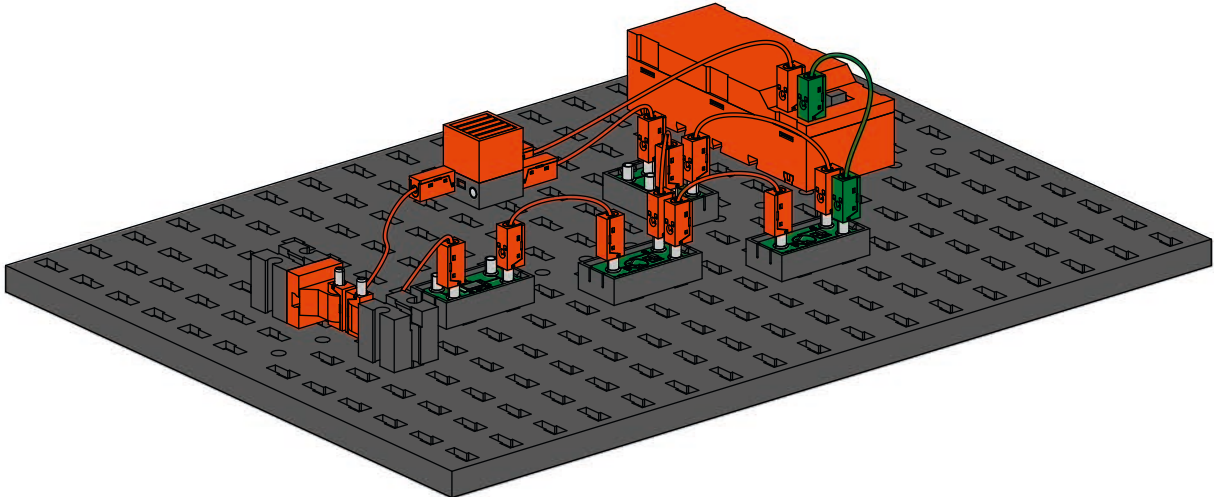



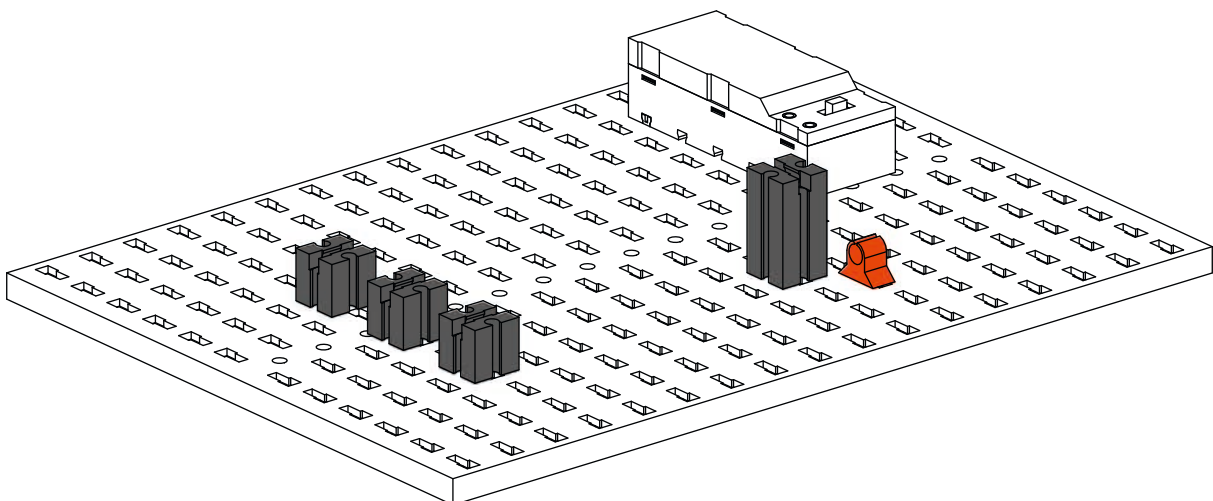
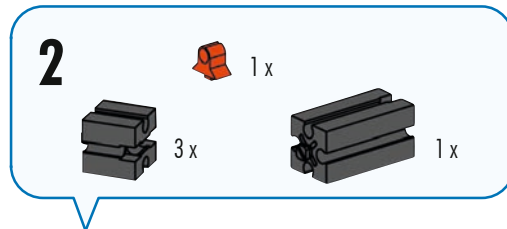
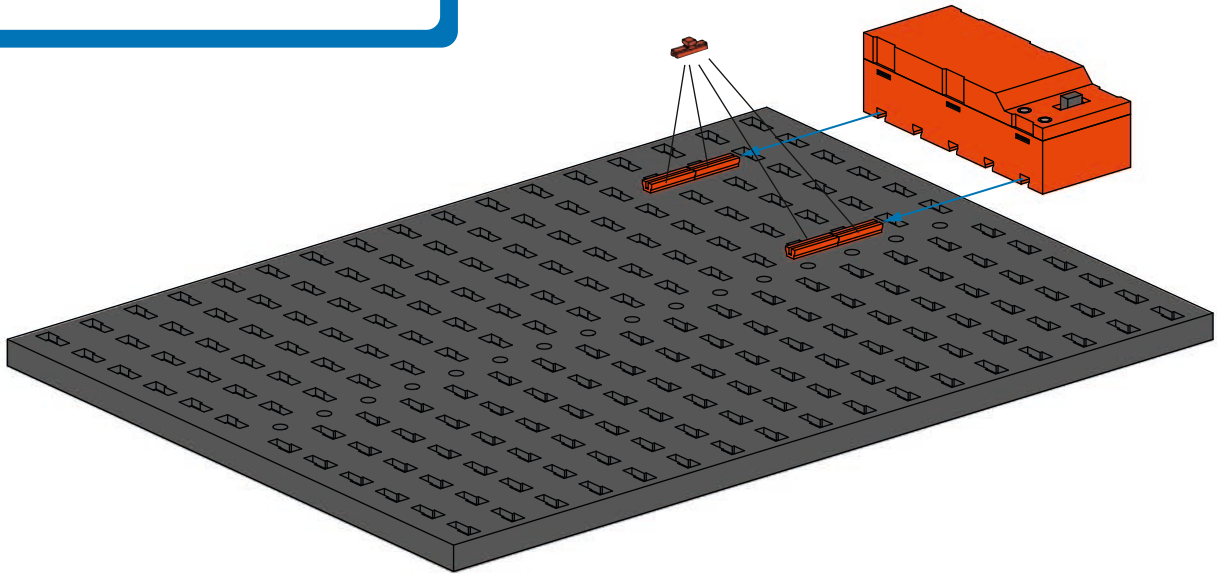
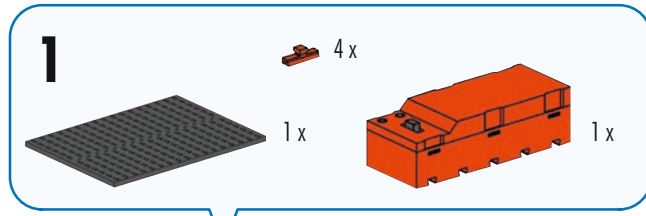
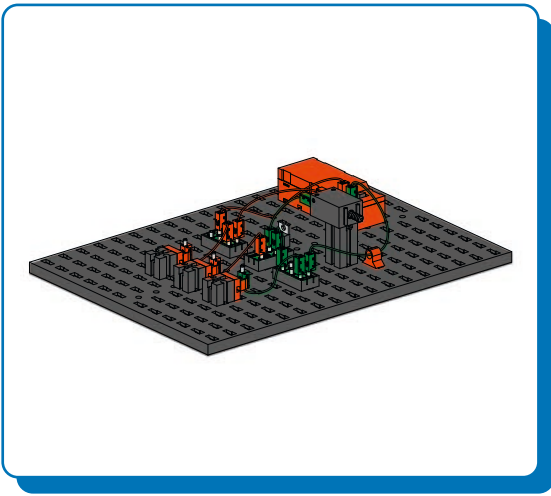

MOSFET
MOSFET
MOSFET

MOSFET
MOSFET
MOSFET

MOSFET
МОП-транзистор
晶体管



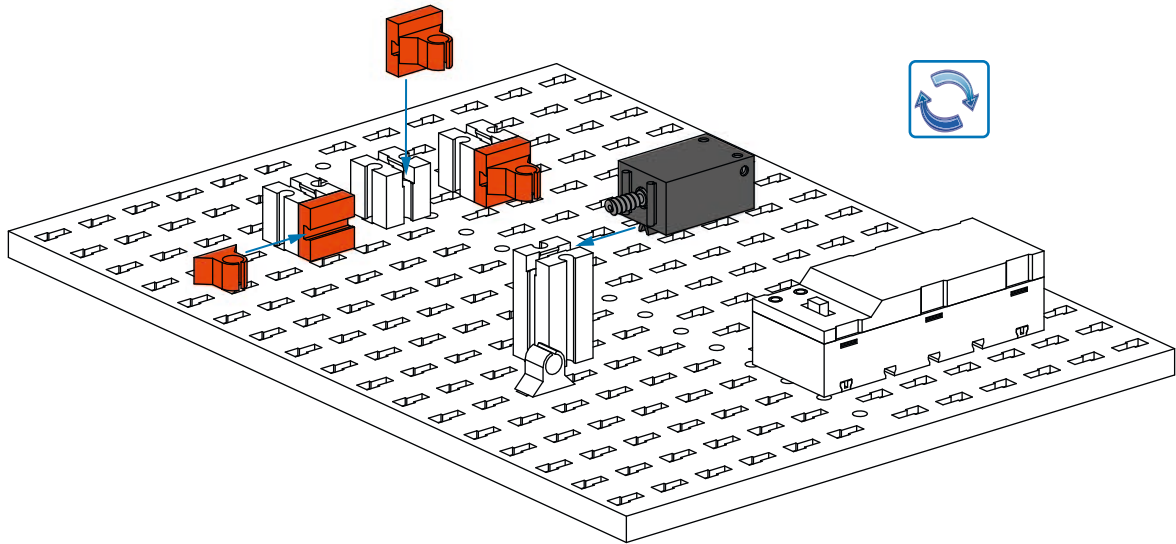

3

1 x  3 x  3 x 



4

2 x  1 x  1 x 

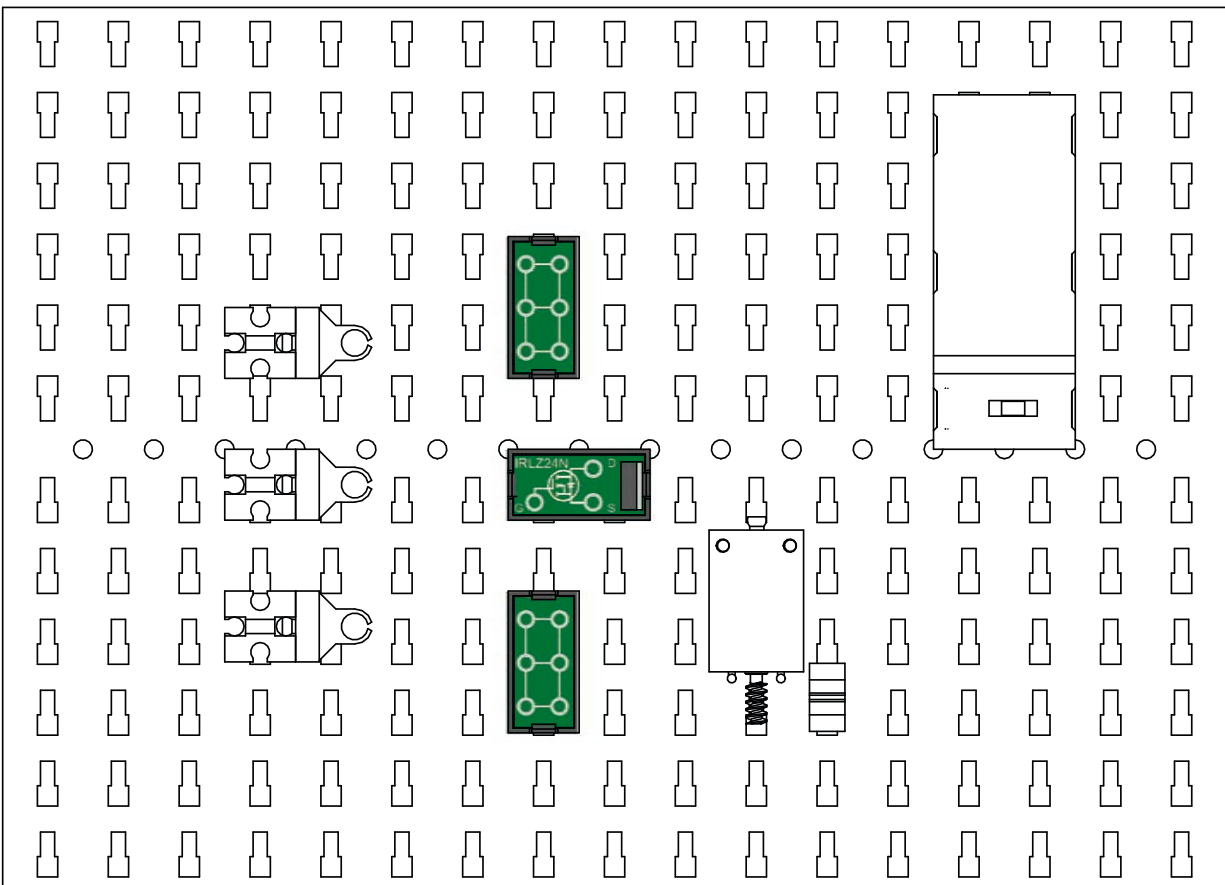

5

2 x - 10 cm
2 x - 15 cm

3 x - 10 cm
1 x - 15 cm

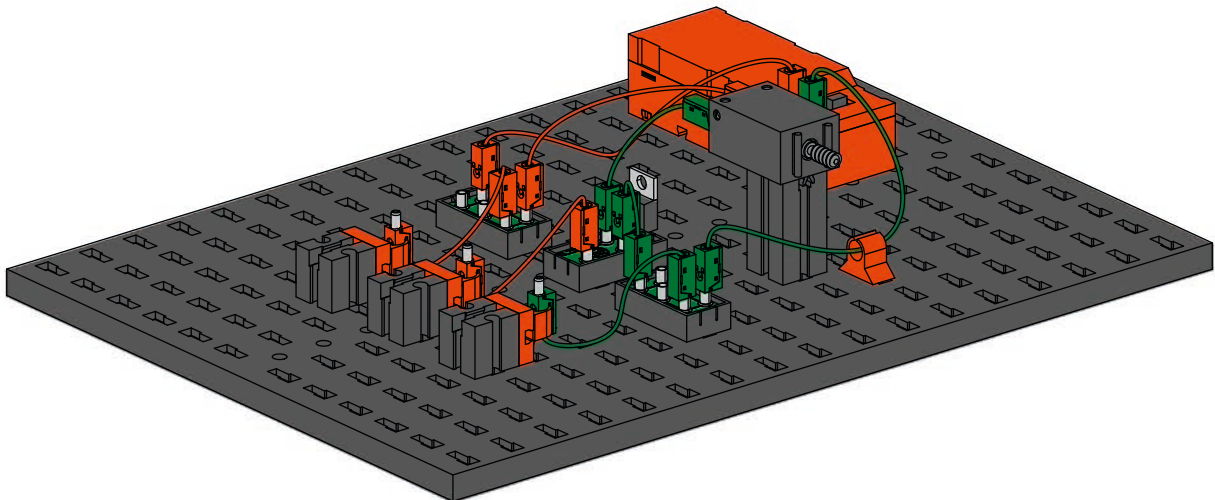
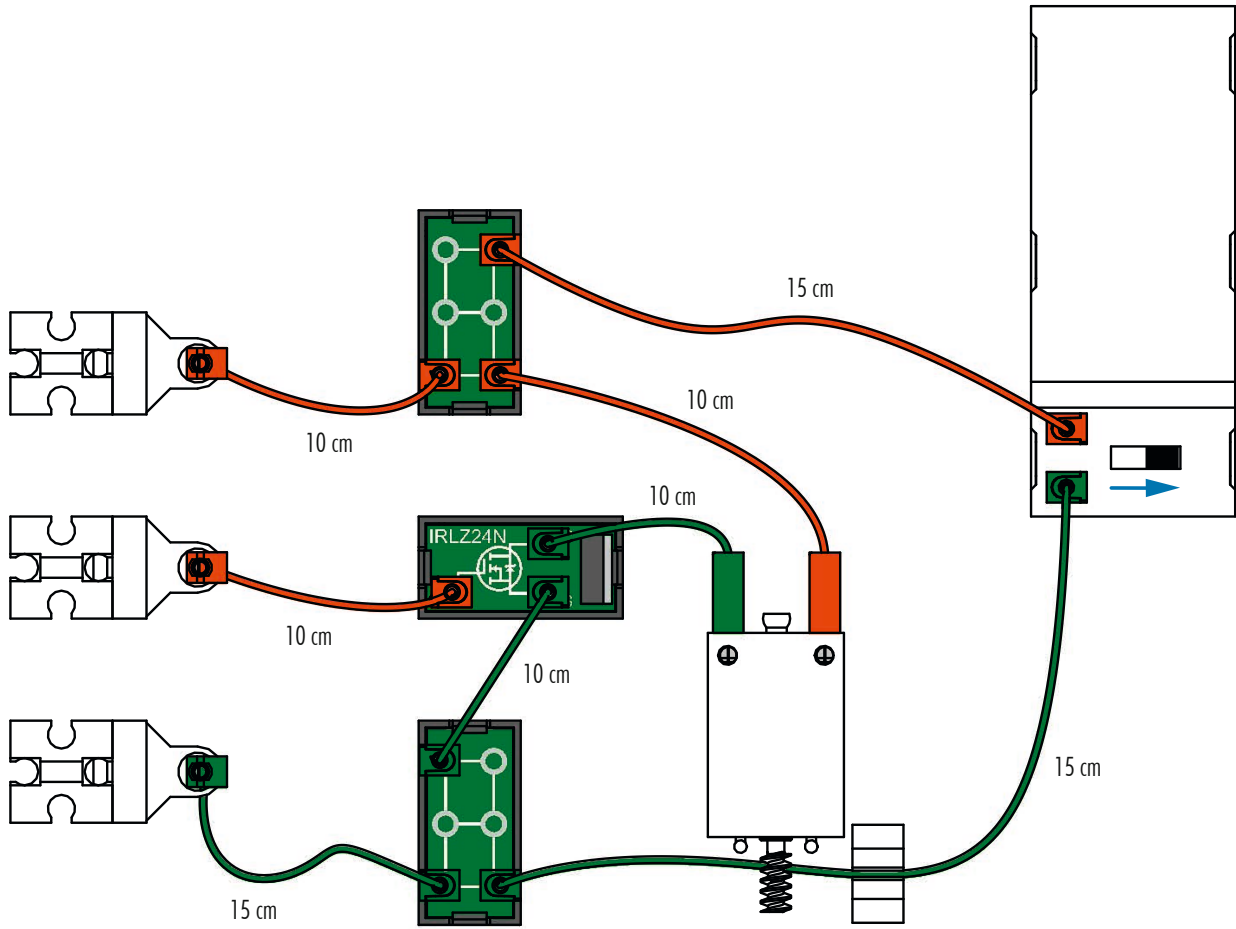

MOSFET - einfache Schal-
tung
MOSFET - simple circuit
MOSFET - circuit simple

MOSFET - eenvoudige
schakeling
MOSFET - circuito simple
MOSFET - circuito simples

MOSFET - circuito semplice
МОП-транзистор -
простая схема
晶体管 - 简单电路

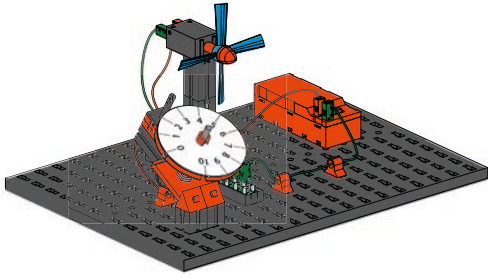

1-4

Seite 24
Page 24
Page 24
Bladzijde 24
Página 24
Pagina 24
Pagina 24
Страница 24
页次 24

3

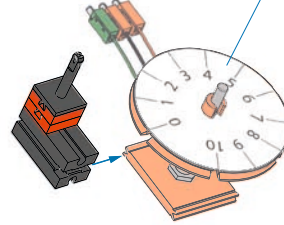

5

4x 2x

4

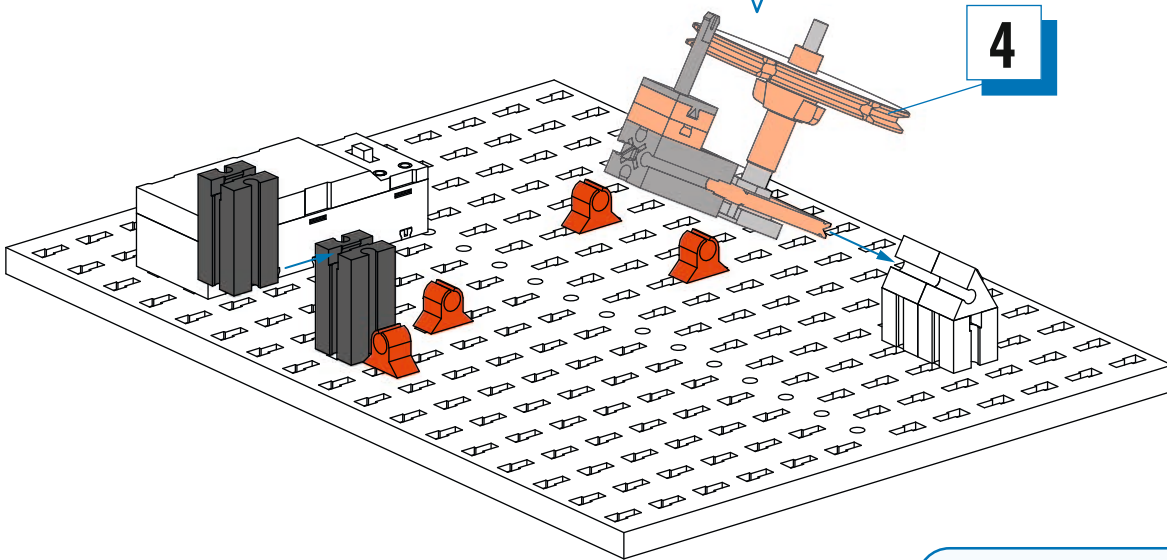

6

1x 1x 1x

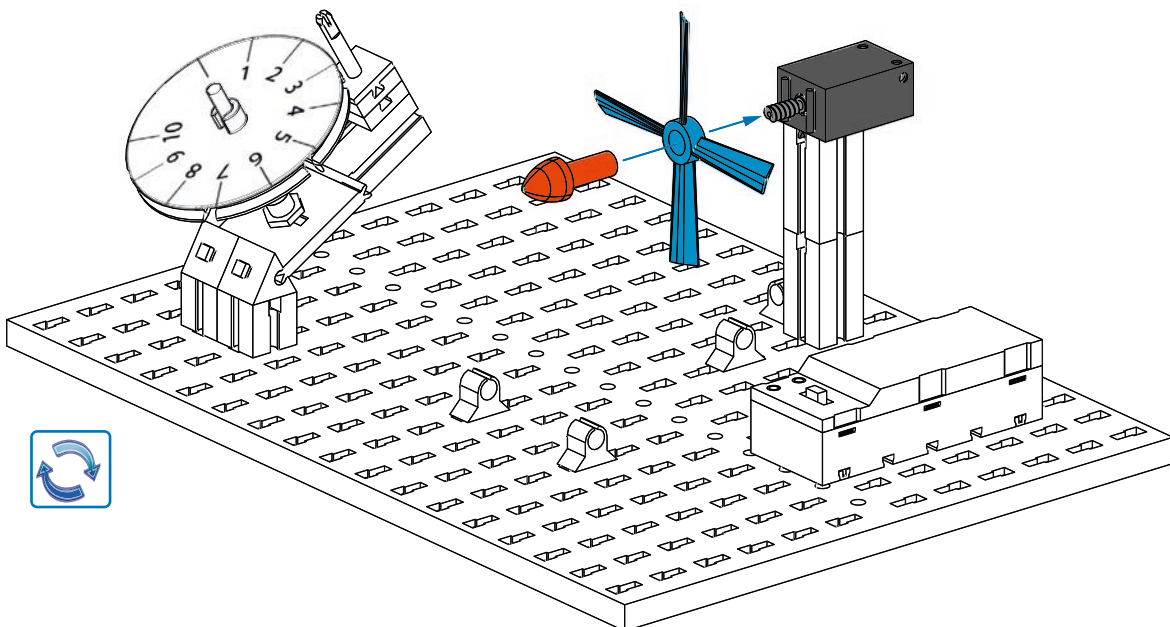

7

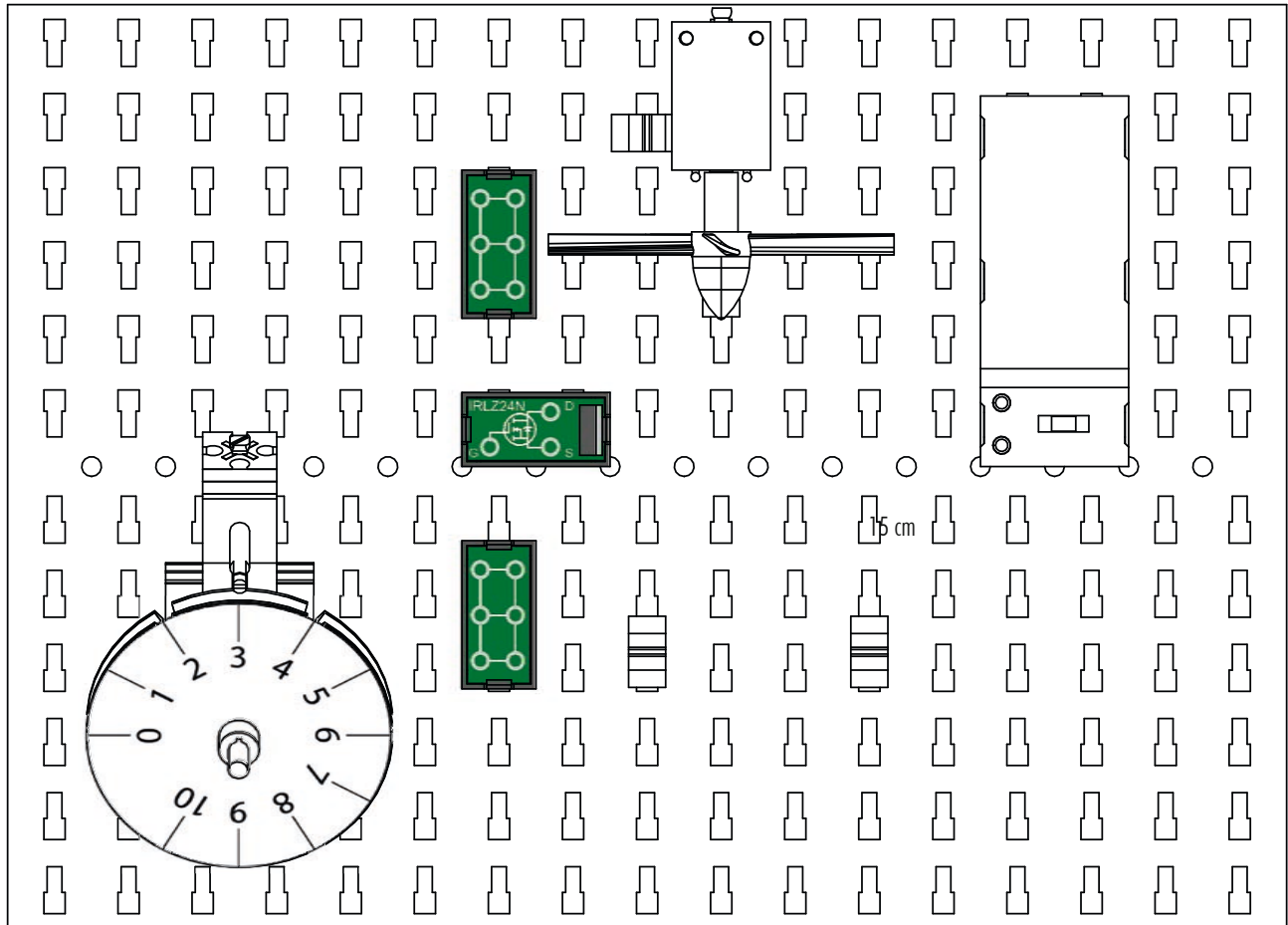

- 8**
- 1 x - 5 cm
 - 2 x - 20 cm
- 1 x - 15 cm
 - 1 x - 20 cm

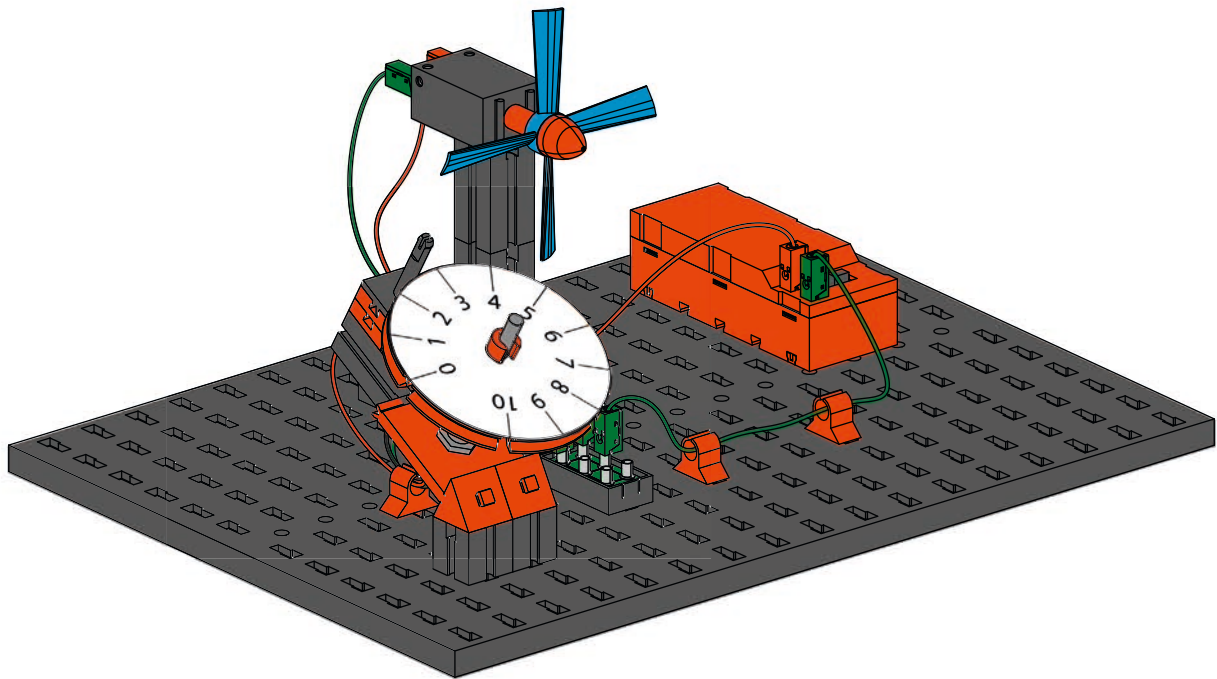
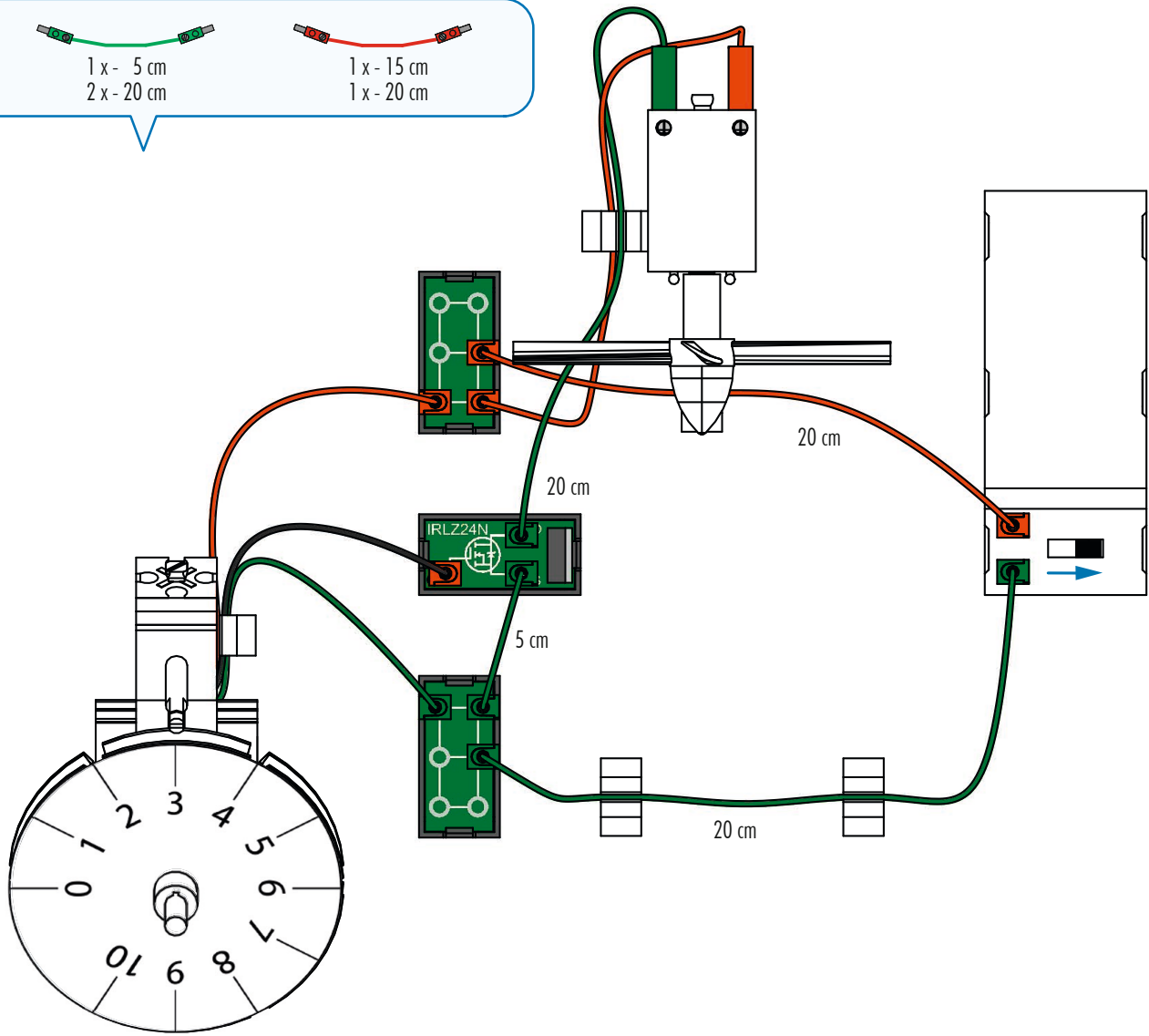

MOSFET Tranferkennlinie
 MOSFET transfer characteristic
 Caractéristique de transfert du
 MOSFET
 MOSFET overdracht karakteristiek

Característica de transferencia del
 MOSFET
 Característica de transferência
 MOSFET
 Caratteristica di trasferimento del

MOSFET
 Передаточная
 характеристика МОП-
 транзистора
 晶体管 传输特性

1-4

Seite 24
 Page 24
 Page 24
 Bladzijde 24
 Página 24
 Pagina 24
 Pagina 24
 Страница 24
 页次 24

3

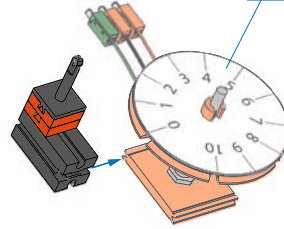

5

 2x

4

6

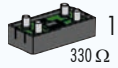

 1x
330 Ω

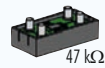
 2x
47 kΩ

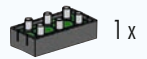
 1x

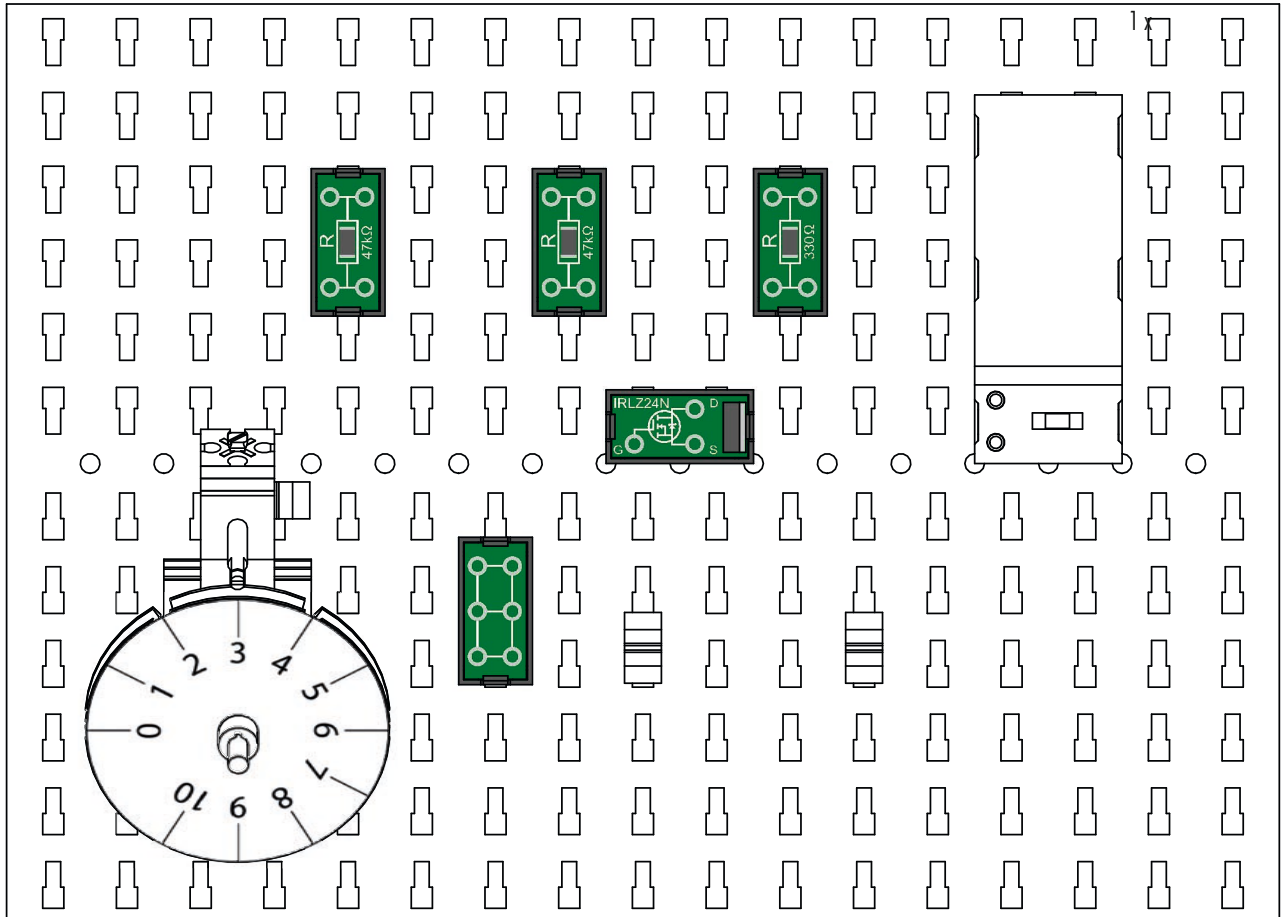
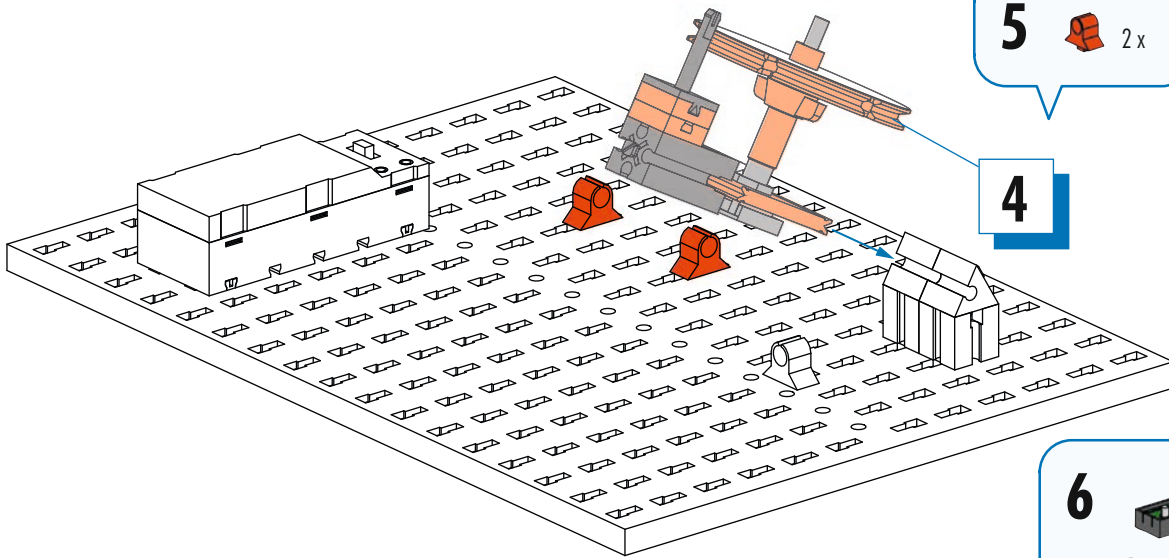
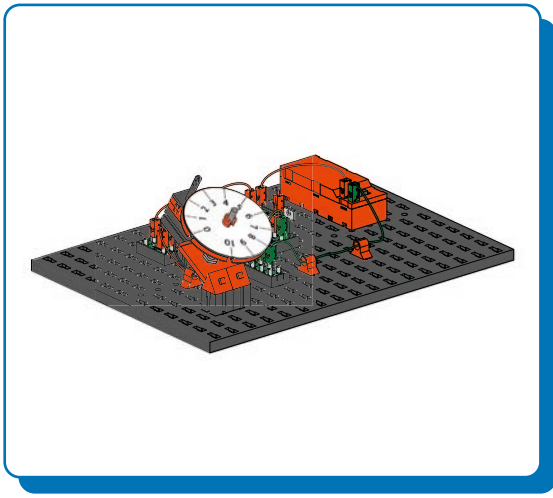

Bistabile Kippschaltung
Bistable tilt circuit
Interrupteur à bascule bistable
Bistabile kipschakeling

Circuito basculante biestable
Interruptor de comutação
biestável

Multivibratore bistabile
Бистабильный
мультивибратор
双稳态拨动开关

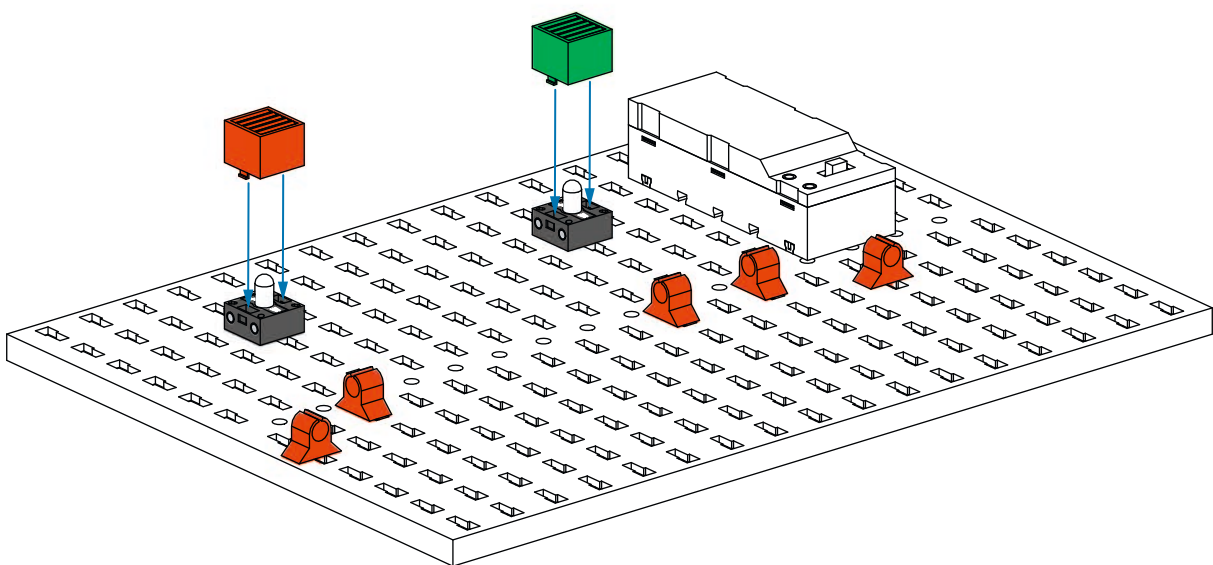
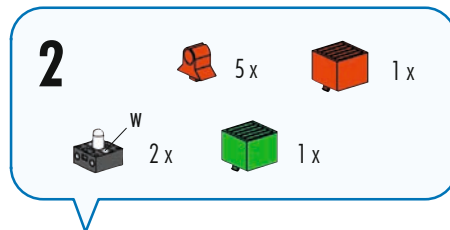
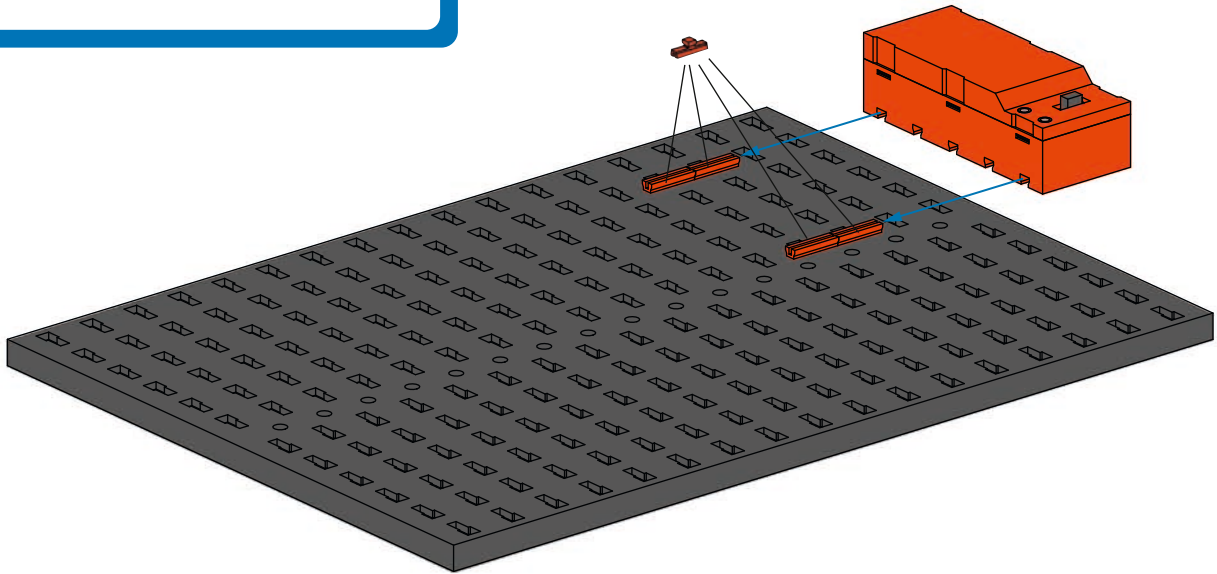
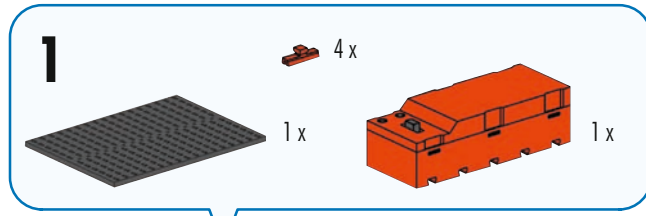
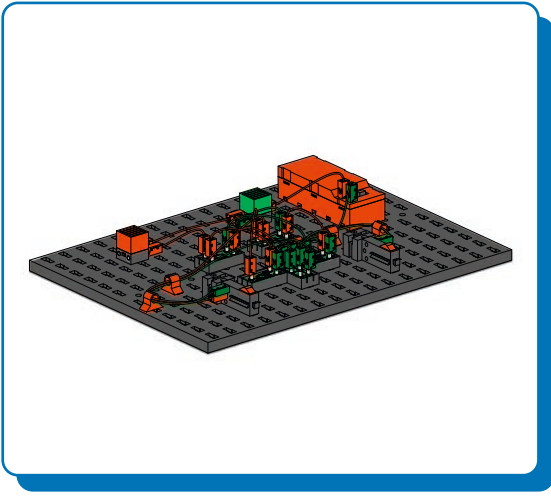

3

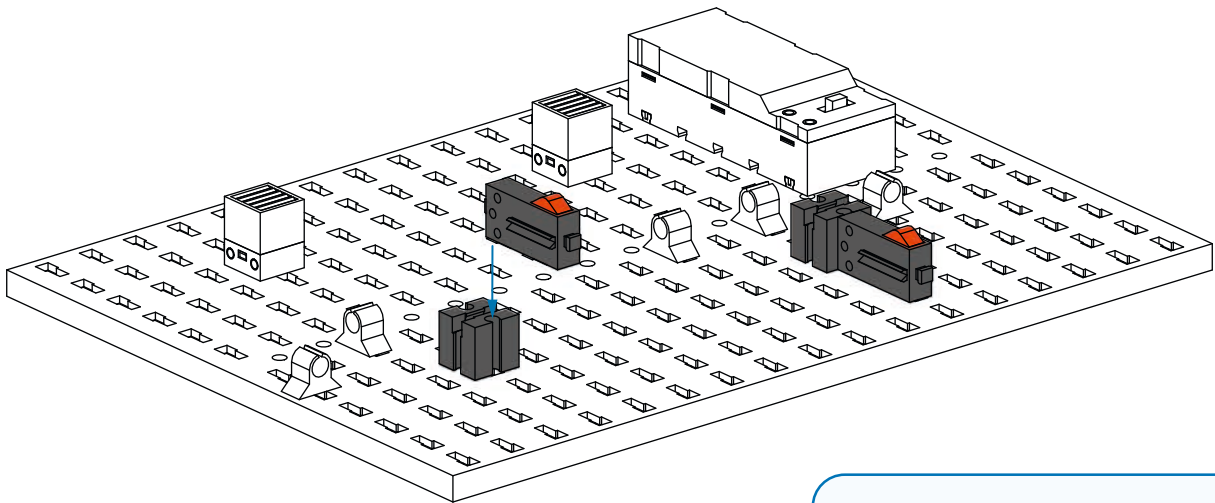
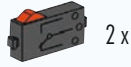

4

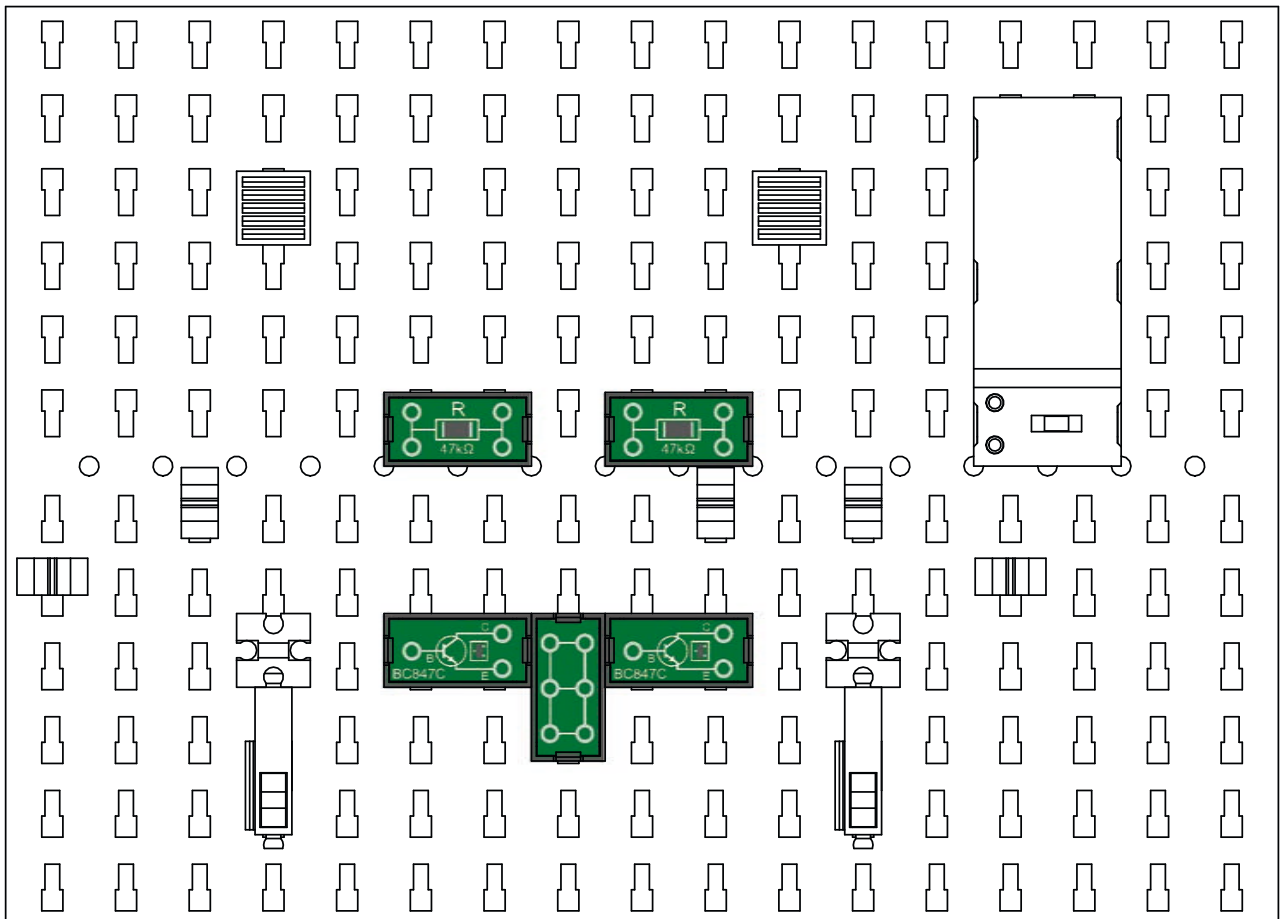

Monostabile Kippschaltung
 Monostable toggle switch
 Interrupteur à bascule mono-
 stable

Monostabile kipschakeling
 Circuito basculante monoestável
 Circuito de comutação mono-
 estável

Multivibratore monostabile
 Моностабильный
 мультивибратор
 单稳态拨动电路

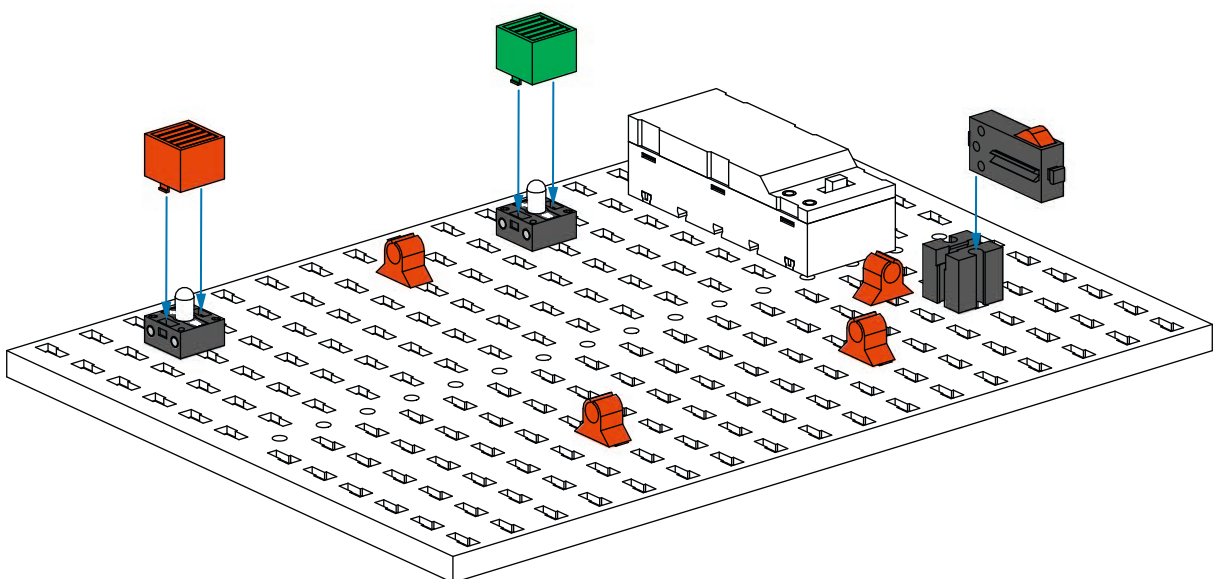
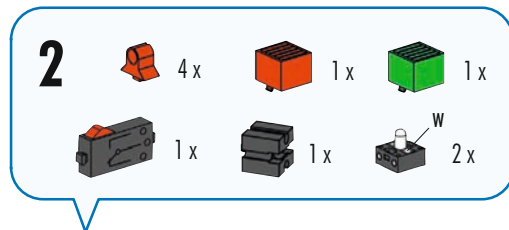
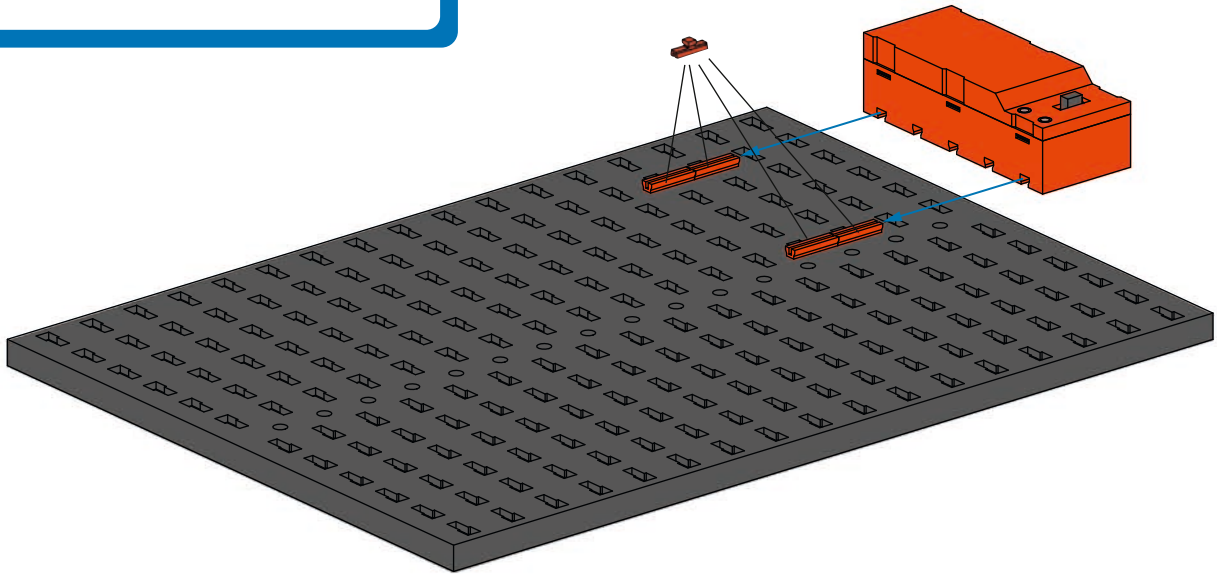
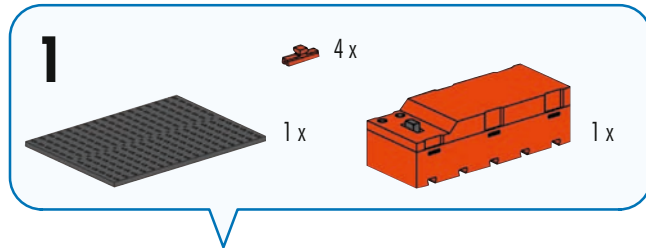
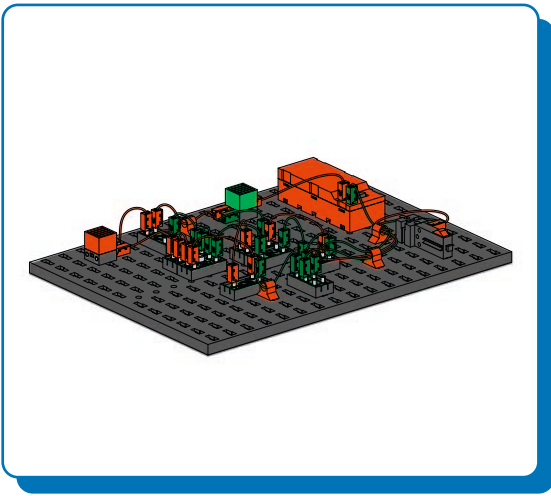

3



1 x

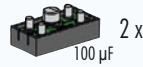

2 x
100 µF

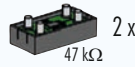

2 x
47 kΩ

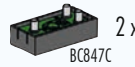

2 x
BC847C

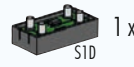

1 x
S1D

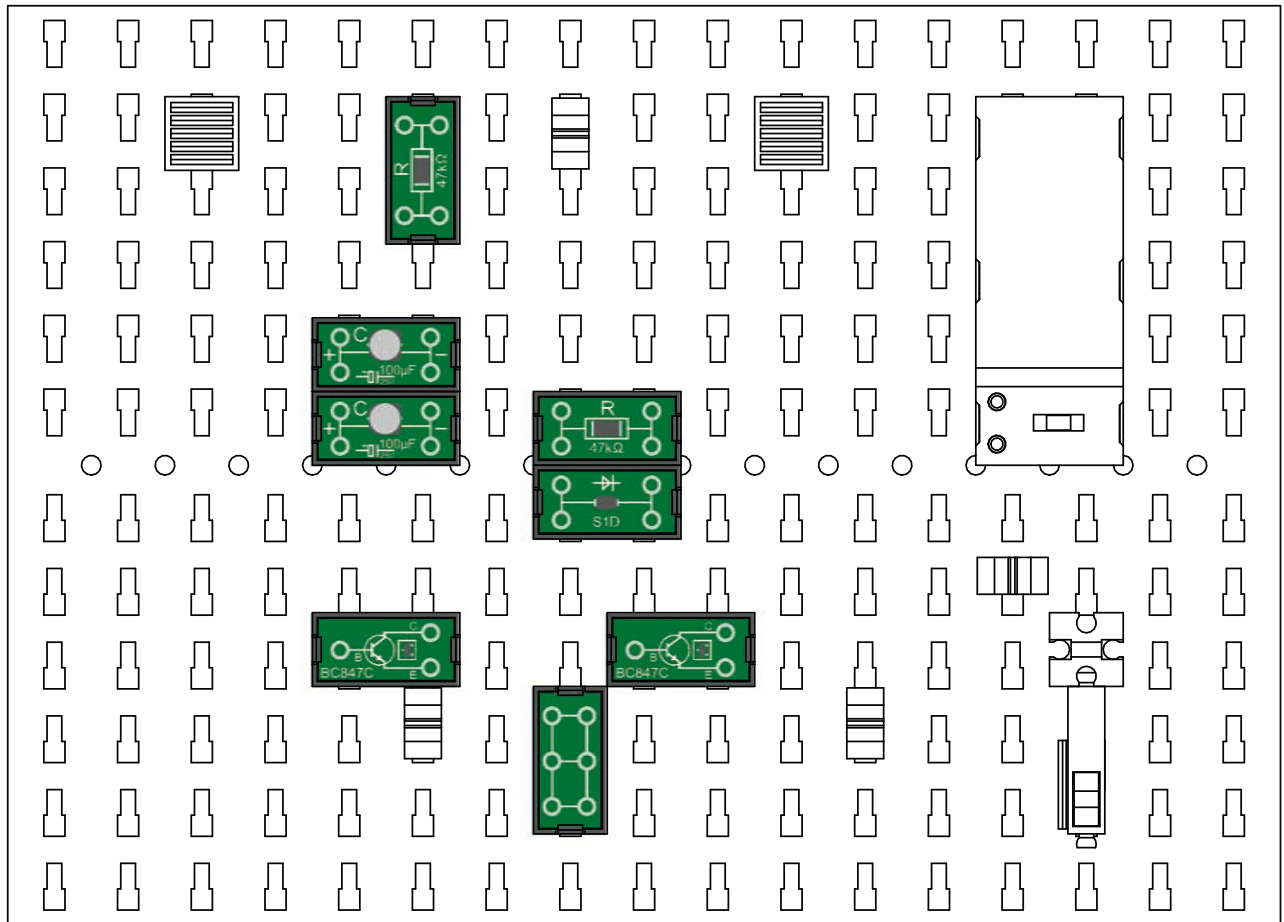

4

3 x - 5 cm
4 x - 10 cm
2 x - 20 cm

2 x - 5 cm
6 x - 10 cm
1 x - 20 cm

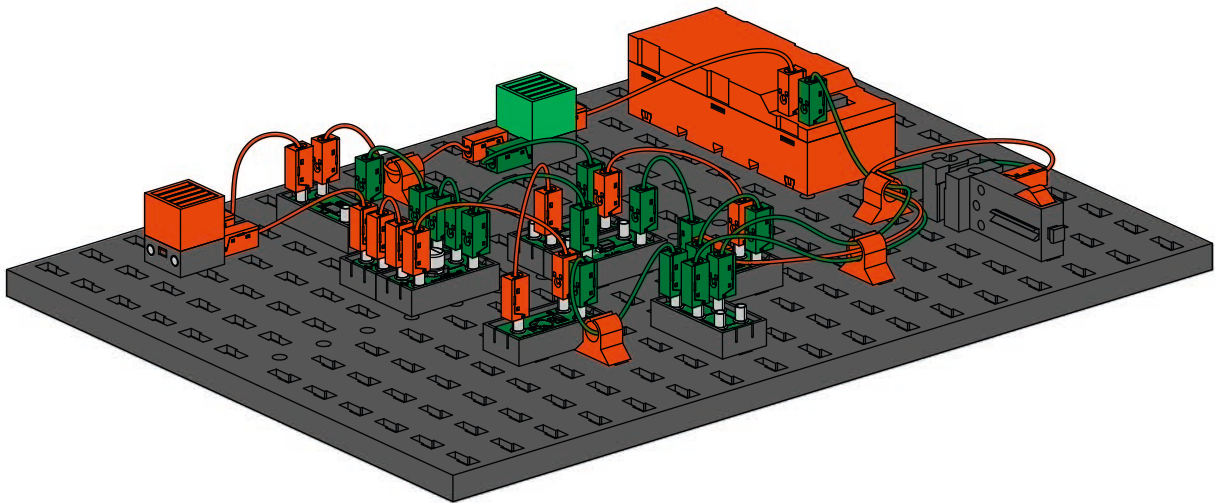
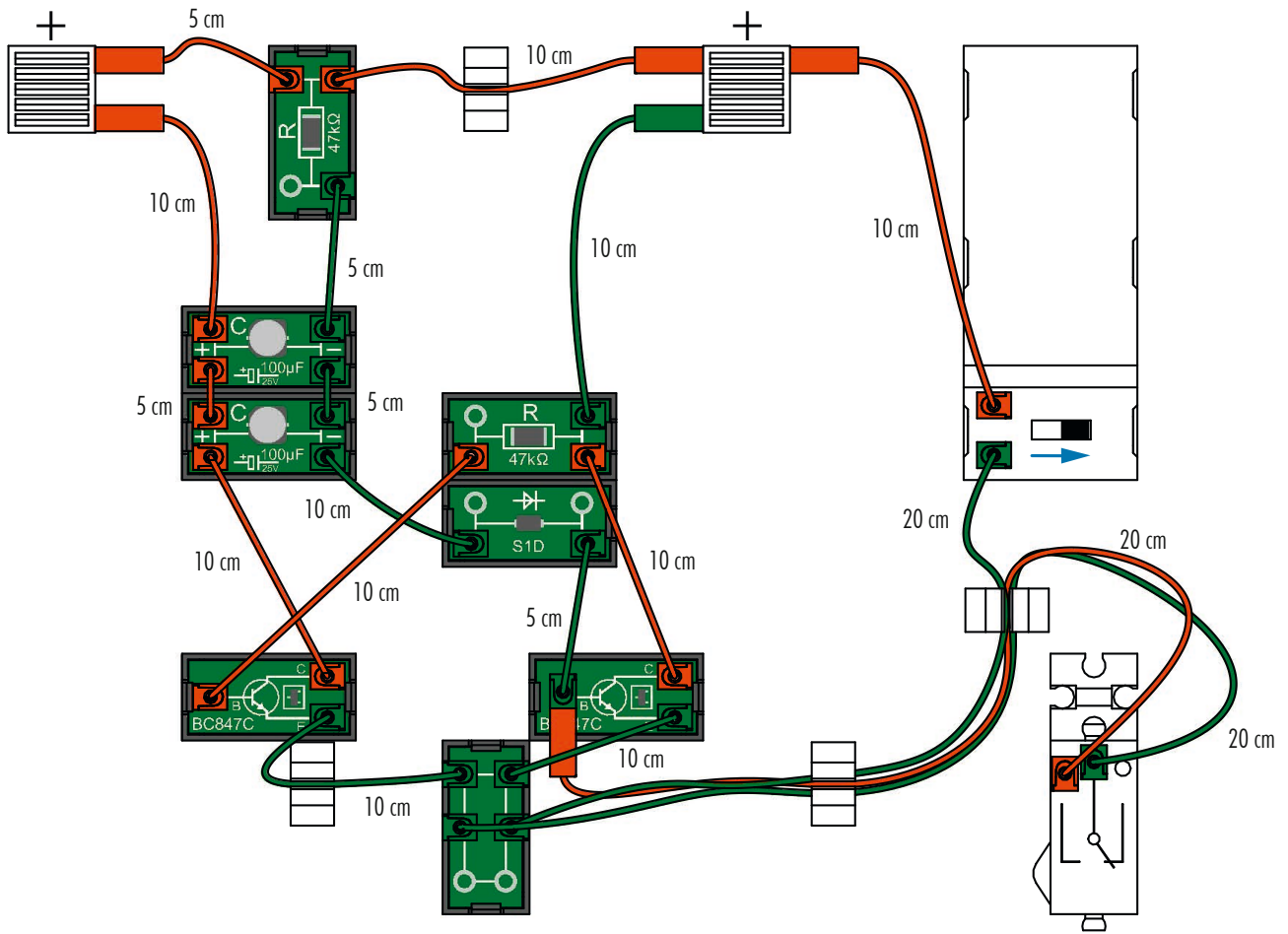

Astable Kippschaltung
Astable toggle switch
Interrupteur à bascule
astable

Astabele kiepschakeling
Circuito basculante aestable
Astable flip-flop

Multivibratore astabile
Астивильный
мультивибратор
雅士利触发电路

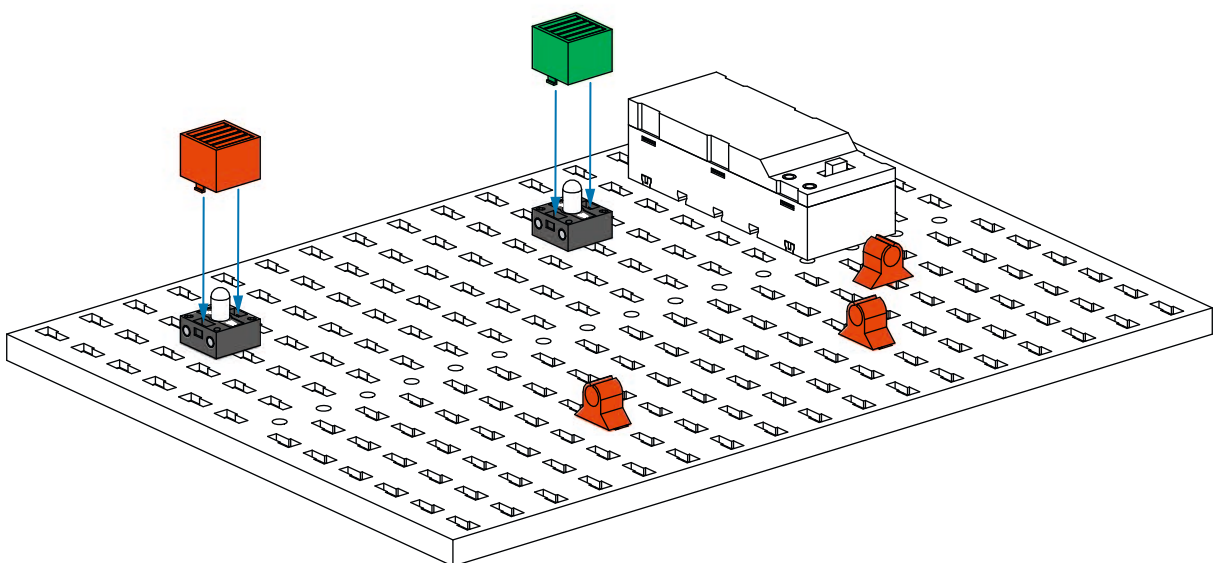
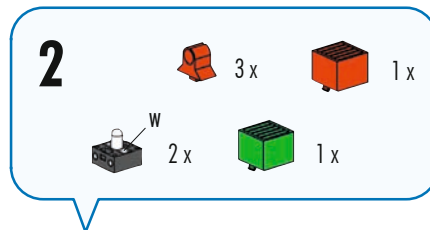
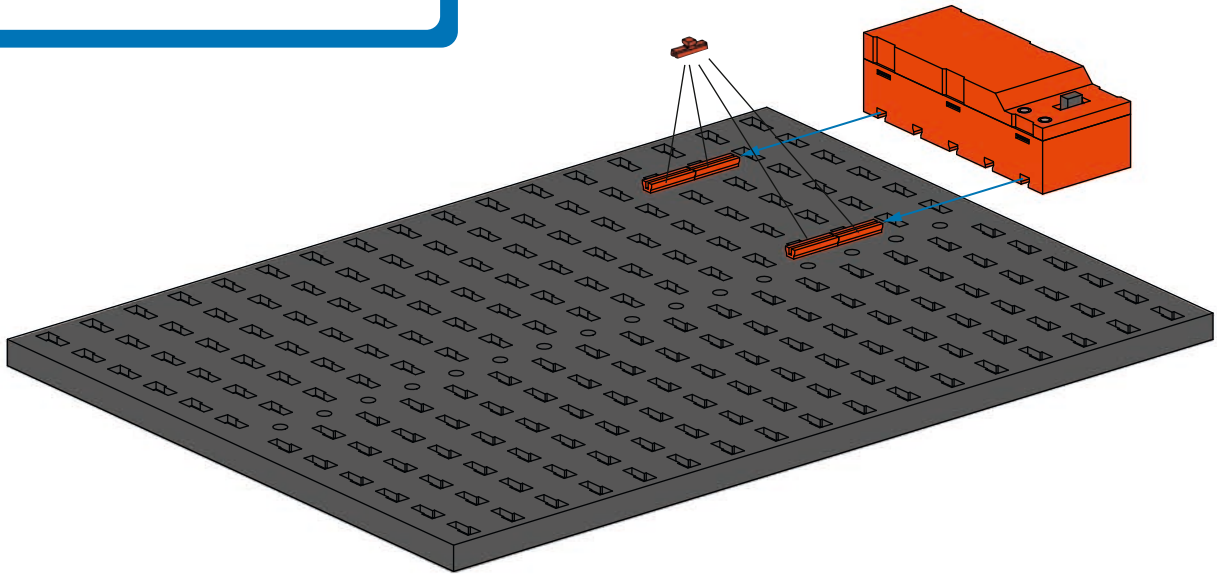
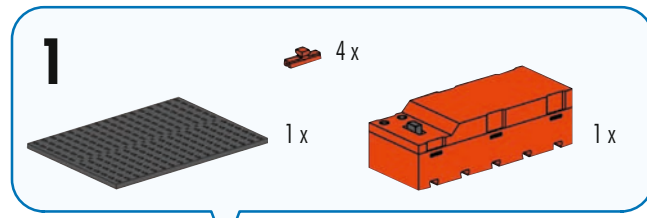
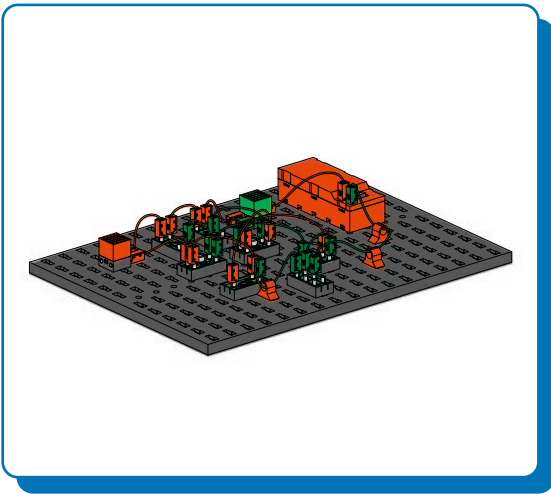

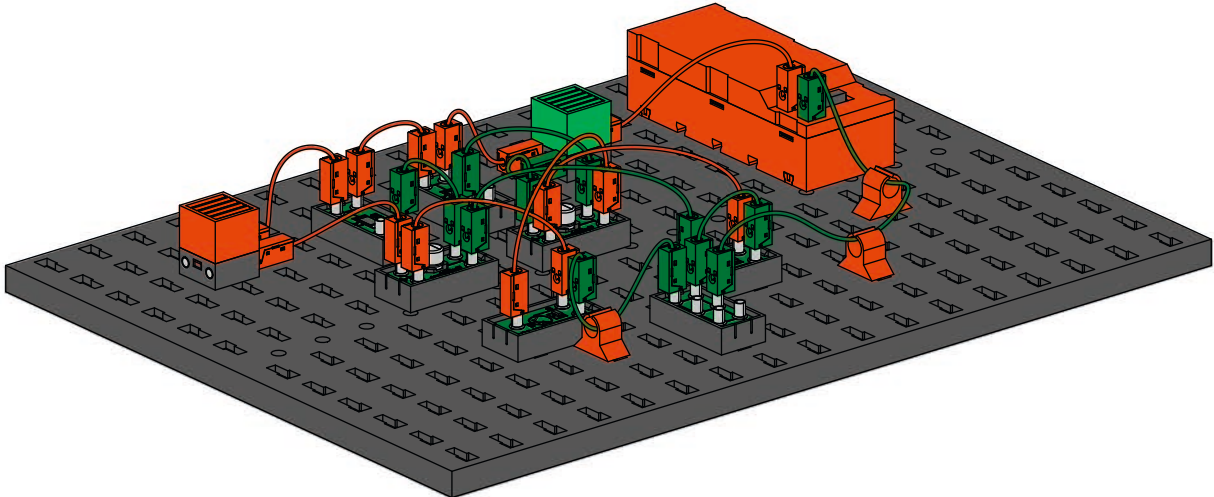

Schmitt Trigger
Schmitt Trigger
Bascule de Schmitt

Schmitt-trigger
Disparador Schmitt
Gatilho Schmitt

Trigger di Schmitt
Триггер Шмитта
施密特触发器

1-4

Seite 24
Page 24
Page 24
Bladzijde 24
Página 24
Pagina 24
Página 24
Страница 24
页次 24

3

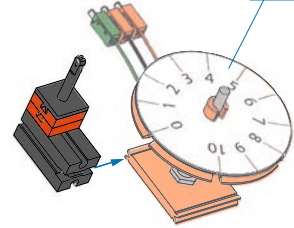

4

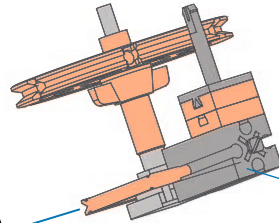

5



6

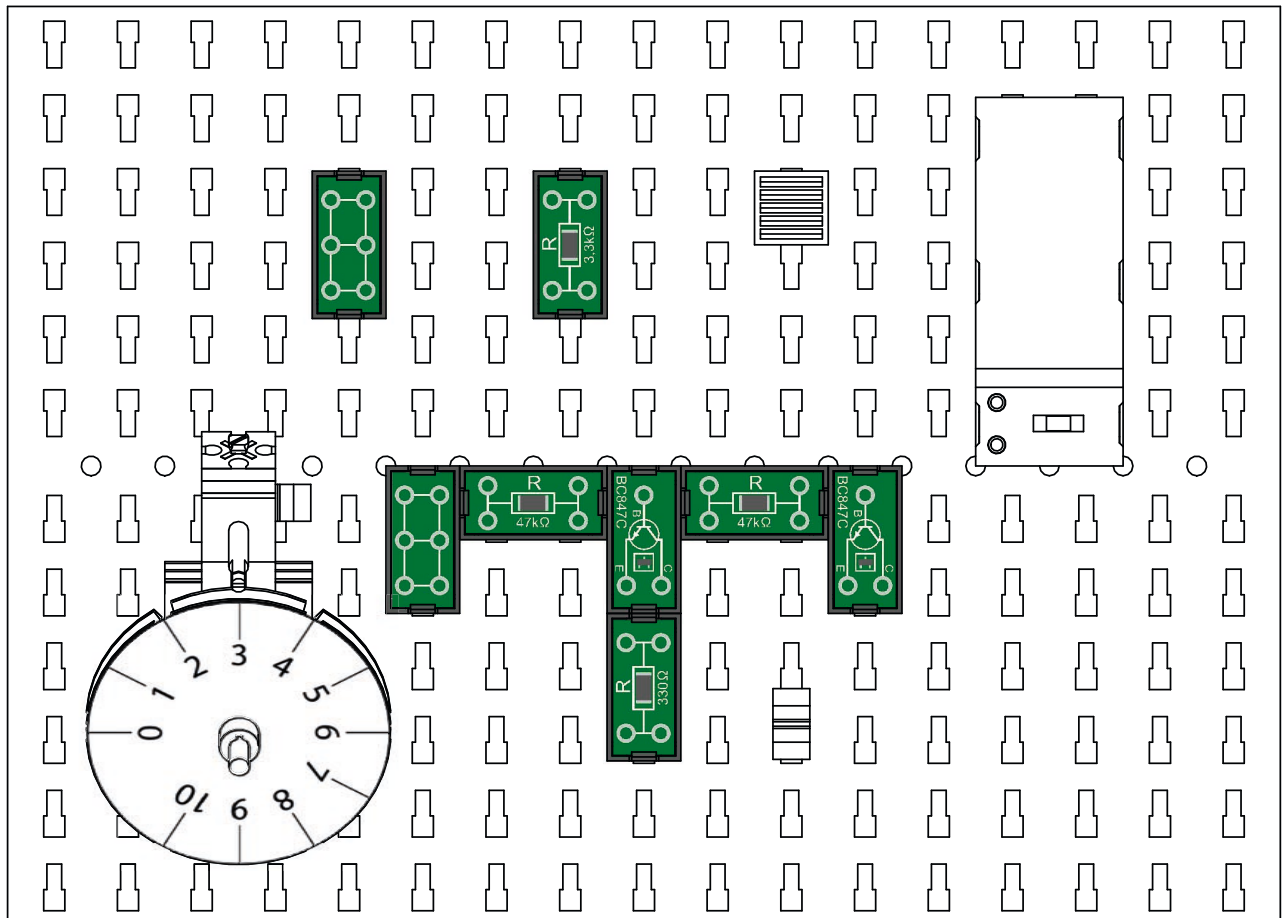
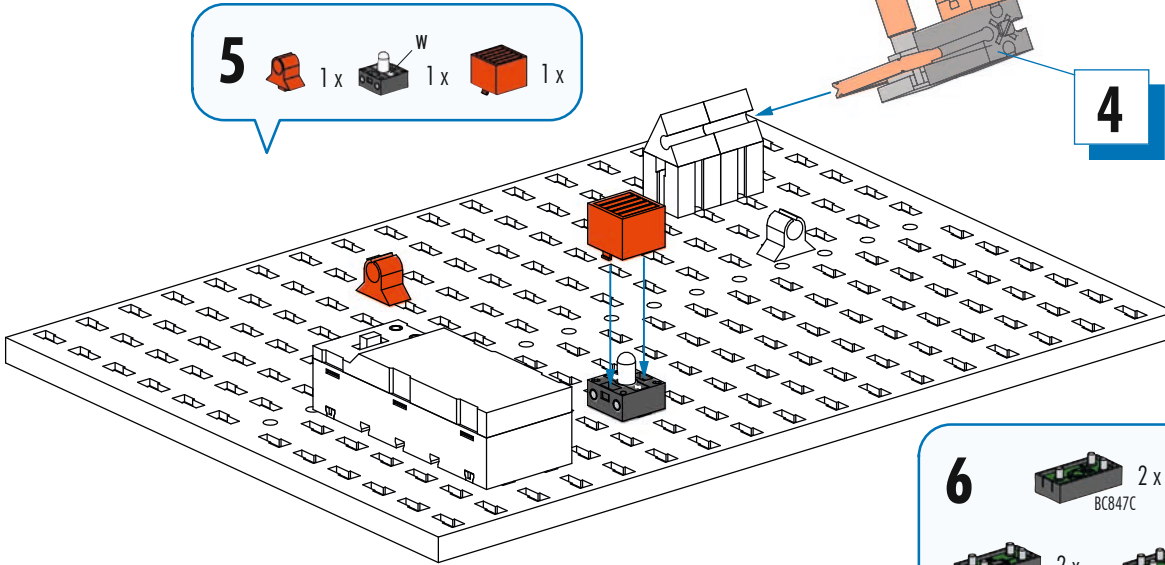
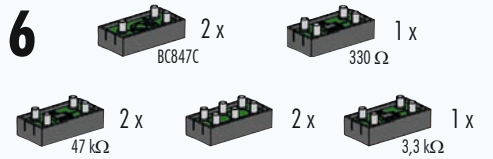

7

2 x - 5 cm
2 x - 10 cm
1 x - 20 cm

3 x - 5 cm
4 x - 10 cm

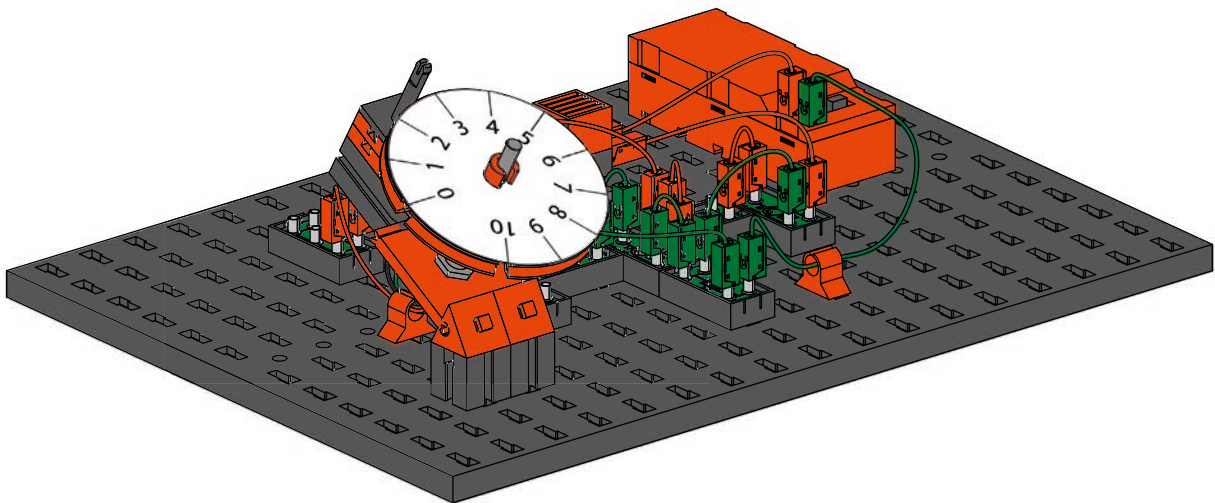
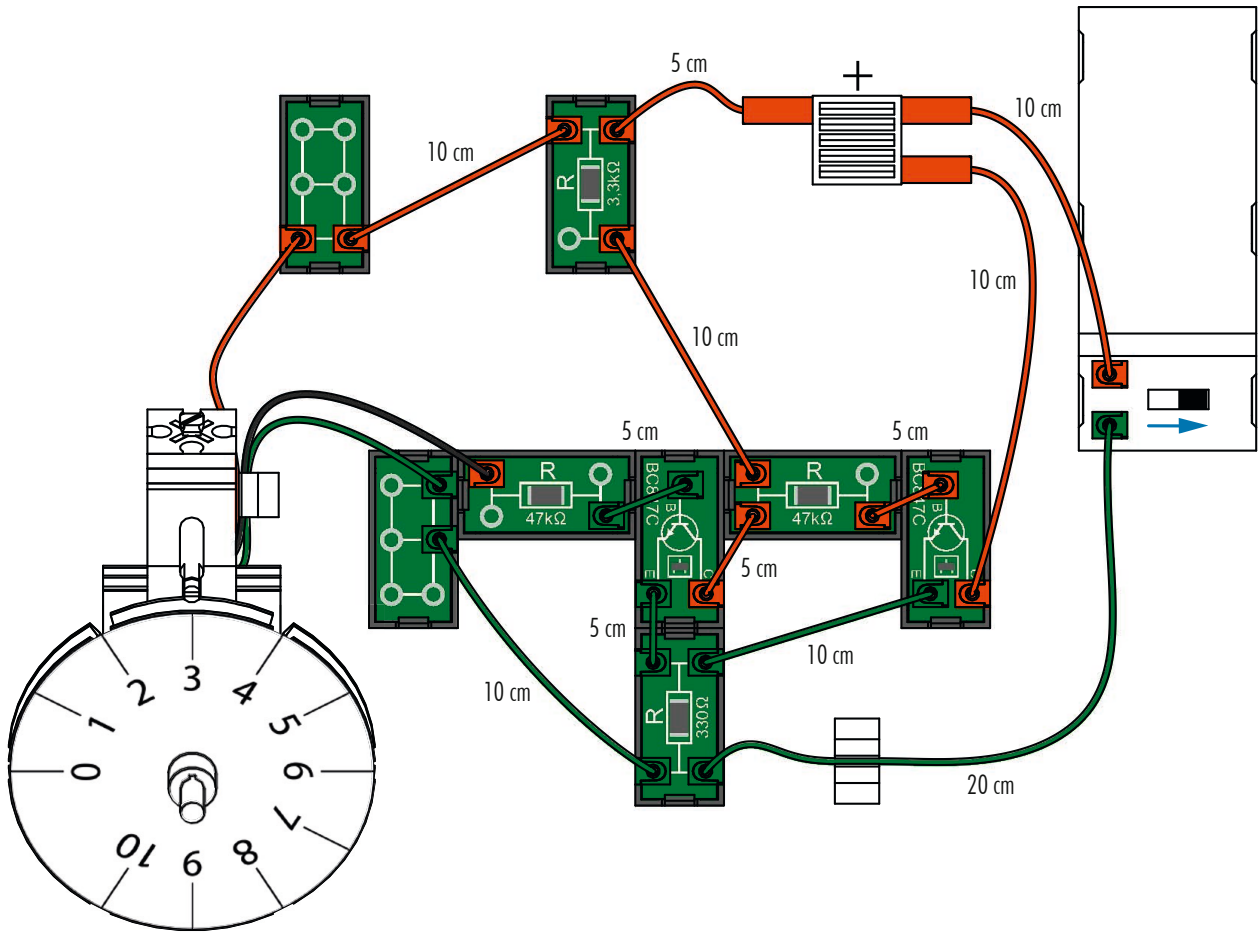

Differenzverstärker
Differential amplifier
Amplificateur différentiel

Diferentiële versterker
Amplificador diferencial
Amplificador diferencial

Amplificatore differenziale
Дифференциальный
усилитель
差分放大器

1-4

Seite 24
Page 24
Page 24
Bladzijde 24
Página 24
Pagina 24
Página 24
Страница 24
页次 24

3

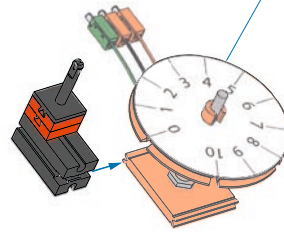

5



4

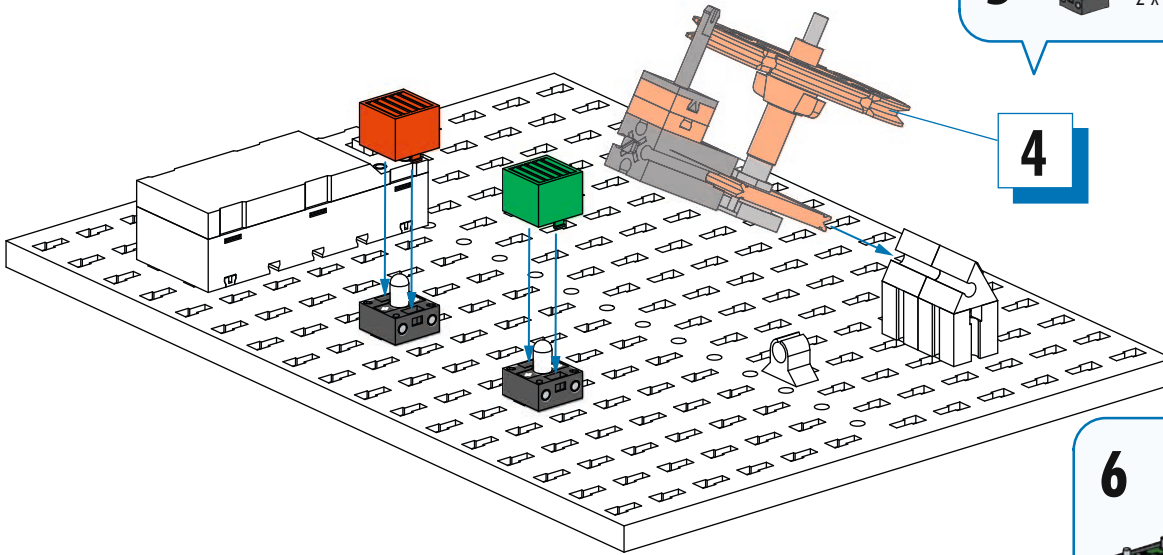

6

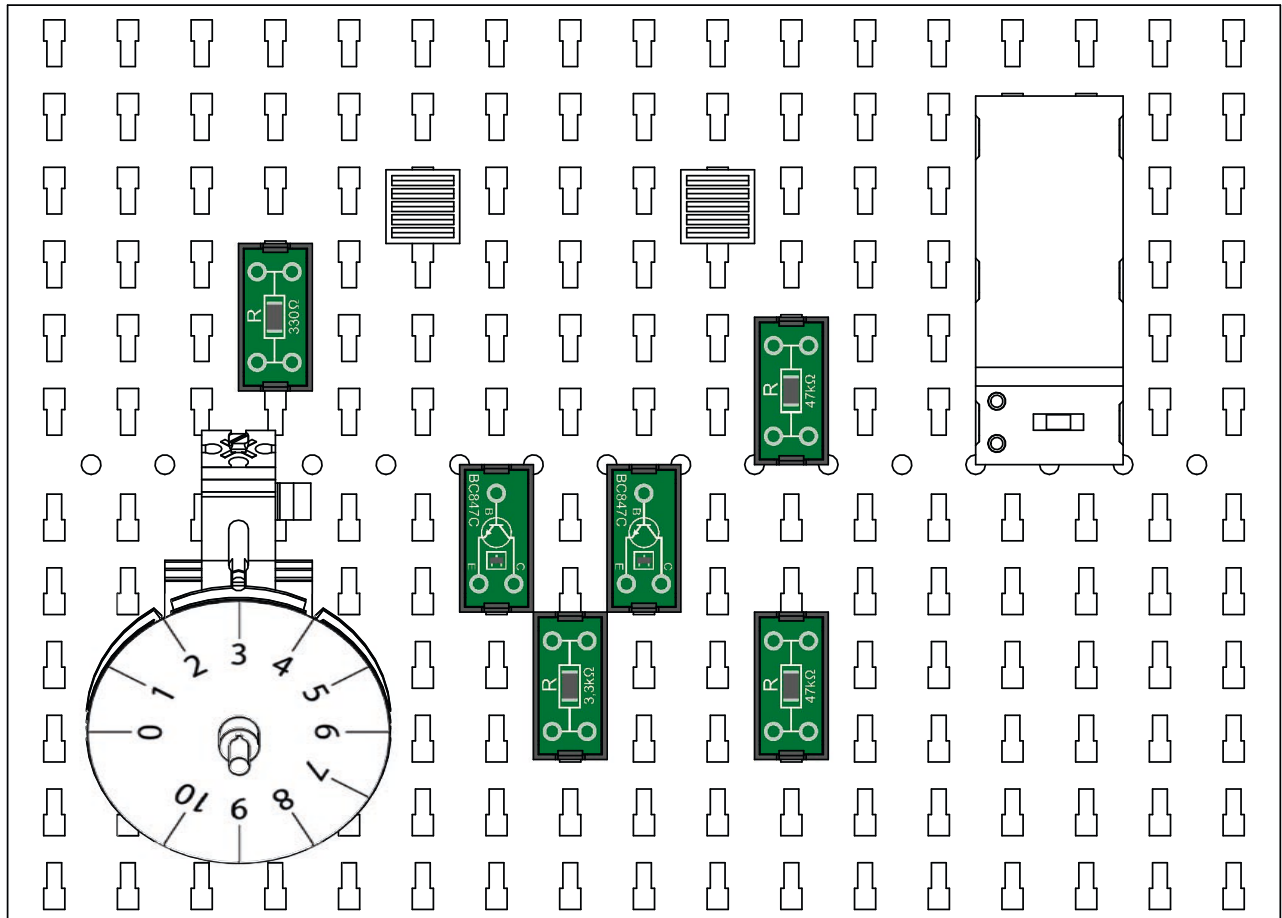
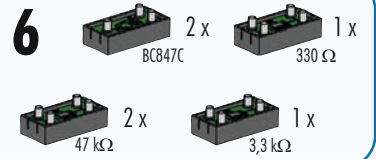

Badezimmerlüftung
Bathroom ventilation
Ventilation de salle de bains

Ventilatie in de badkamer
Ventilación de cuarto de baño
Ventilação da casa de banho

Ventilazione bagno
Вентиляция ванной
комнаты
浴室通风装置

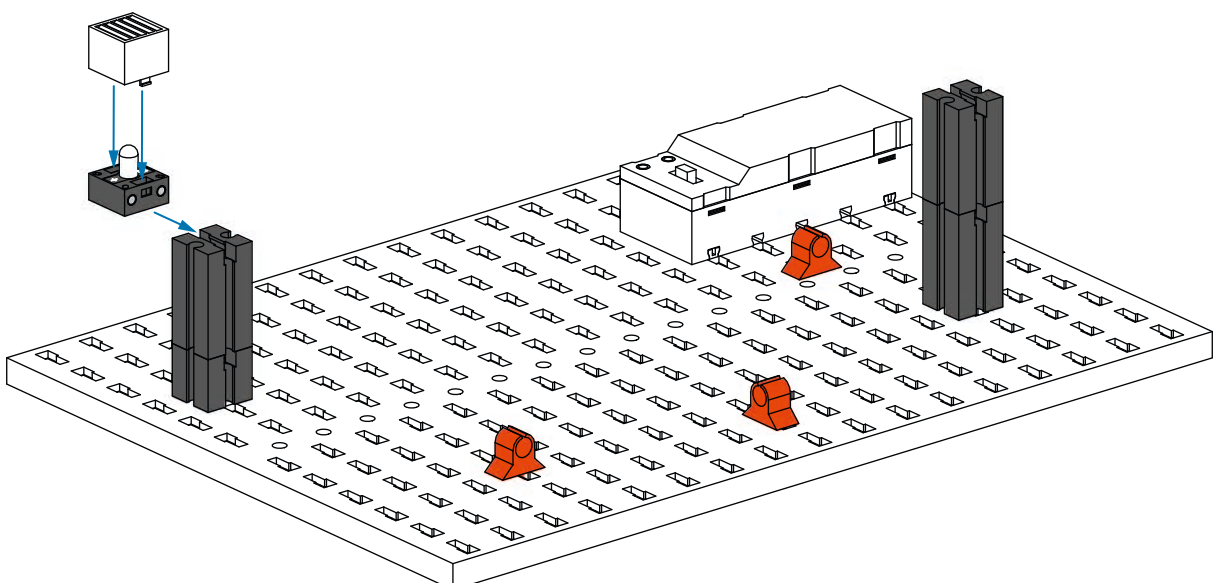
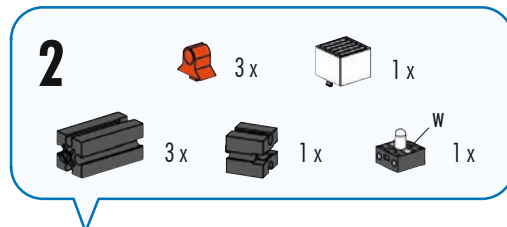
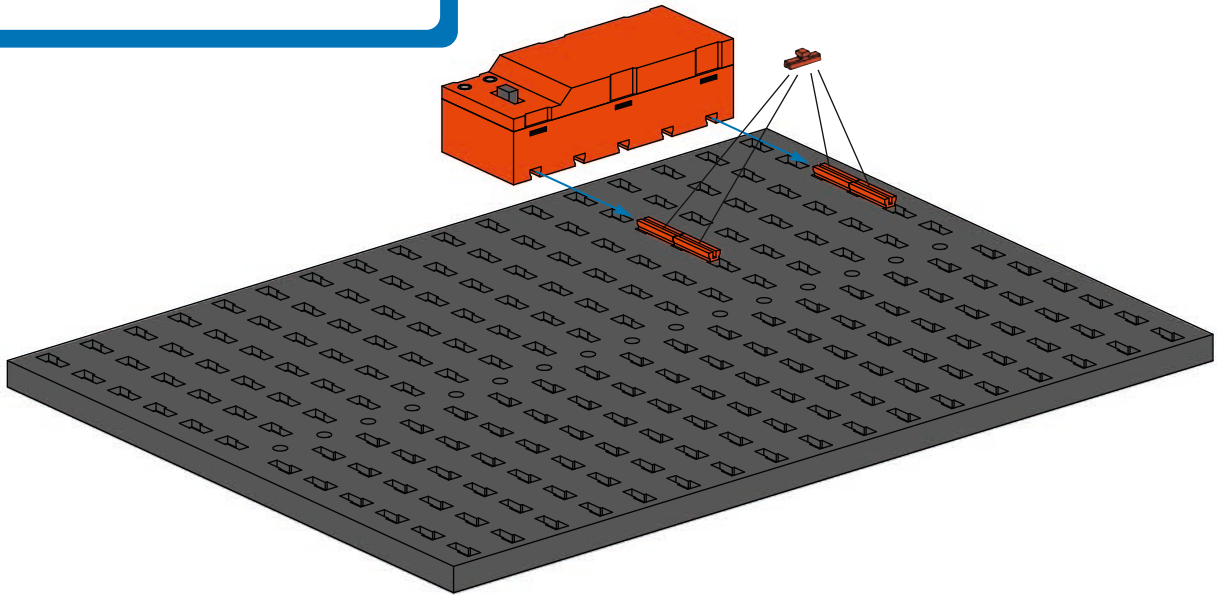
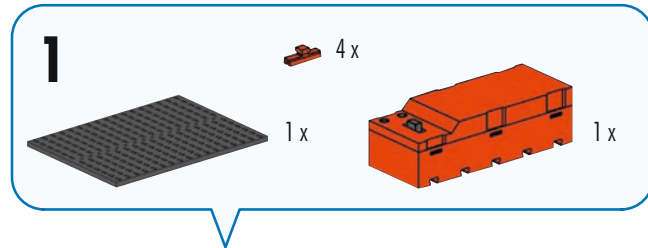
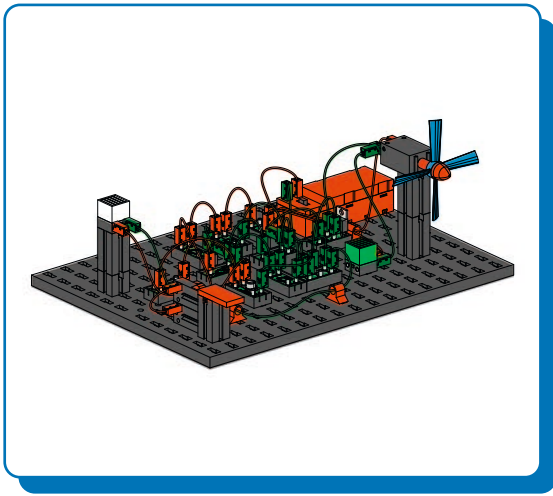

3

- 1x [Small red pin]
- 1x [Orange plate]
- 1x [Green connector]
- 1x [Black connector]
- 2x [Black motor]
- 1x [Black component with 'W' label]

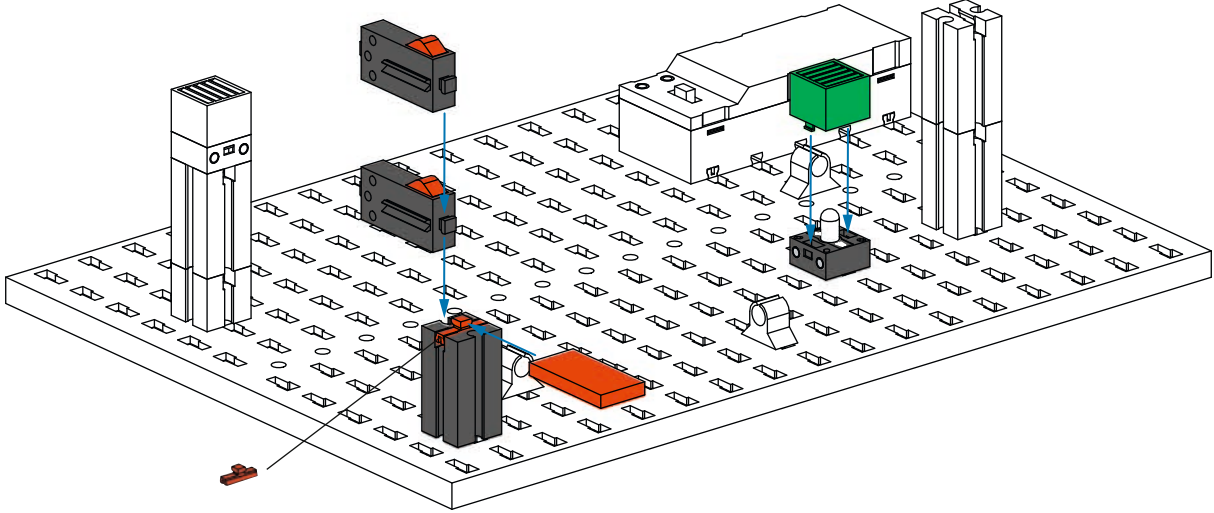

4

- 1x [Red arrow]
- 1x [Black motor]
- 1x [Blue propeller]

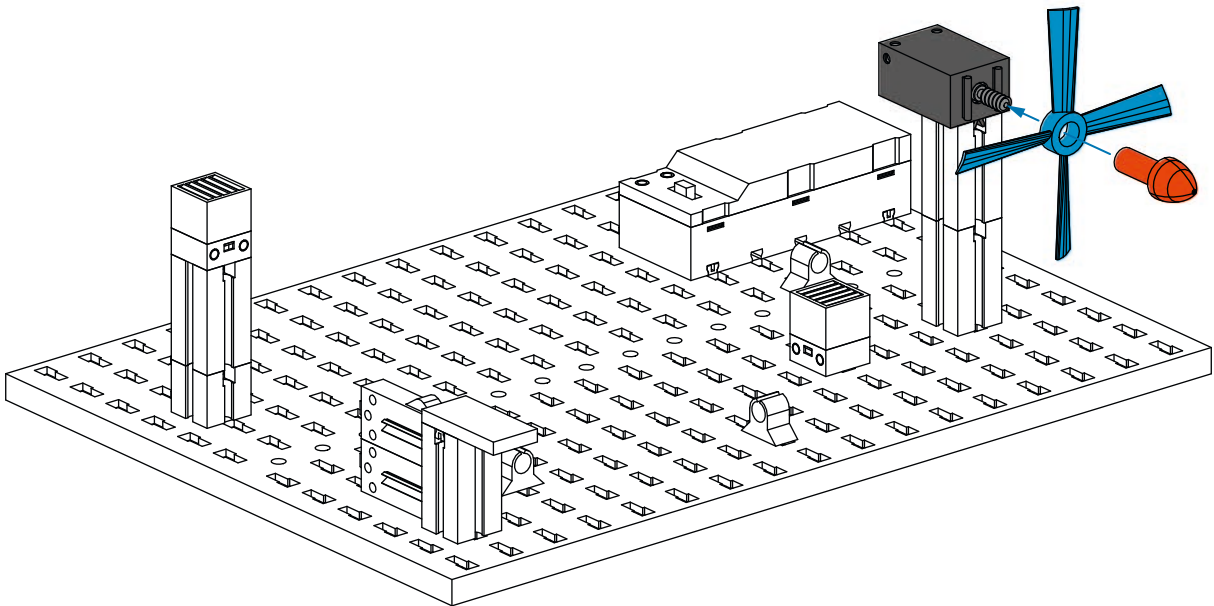

6

3 x - 5 cm
4 x - 10 cm
3 x - 15 cm
2 x - 20 cm
1 x - 30 cm

3 x - 5 cm
4 x - 10 cm
1 x - 15 cm
2 x - 20 cm

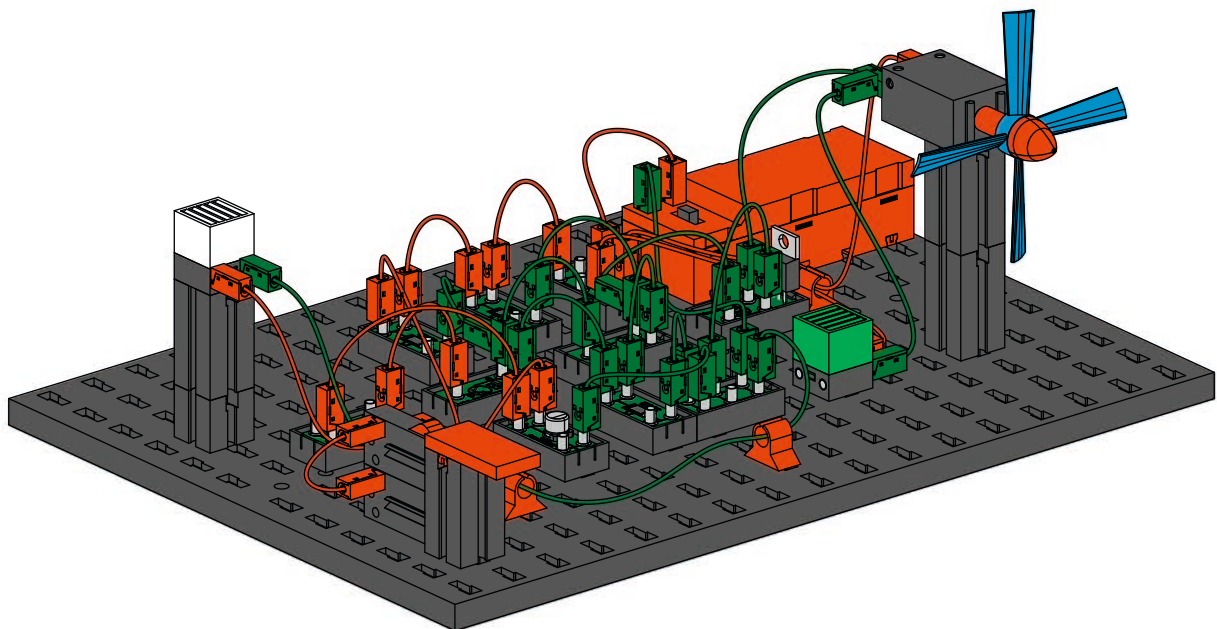
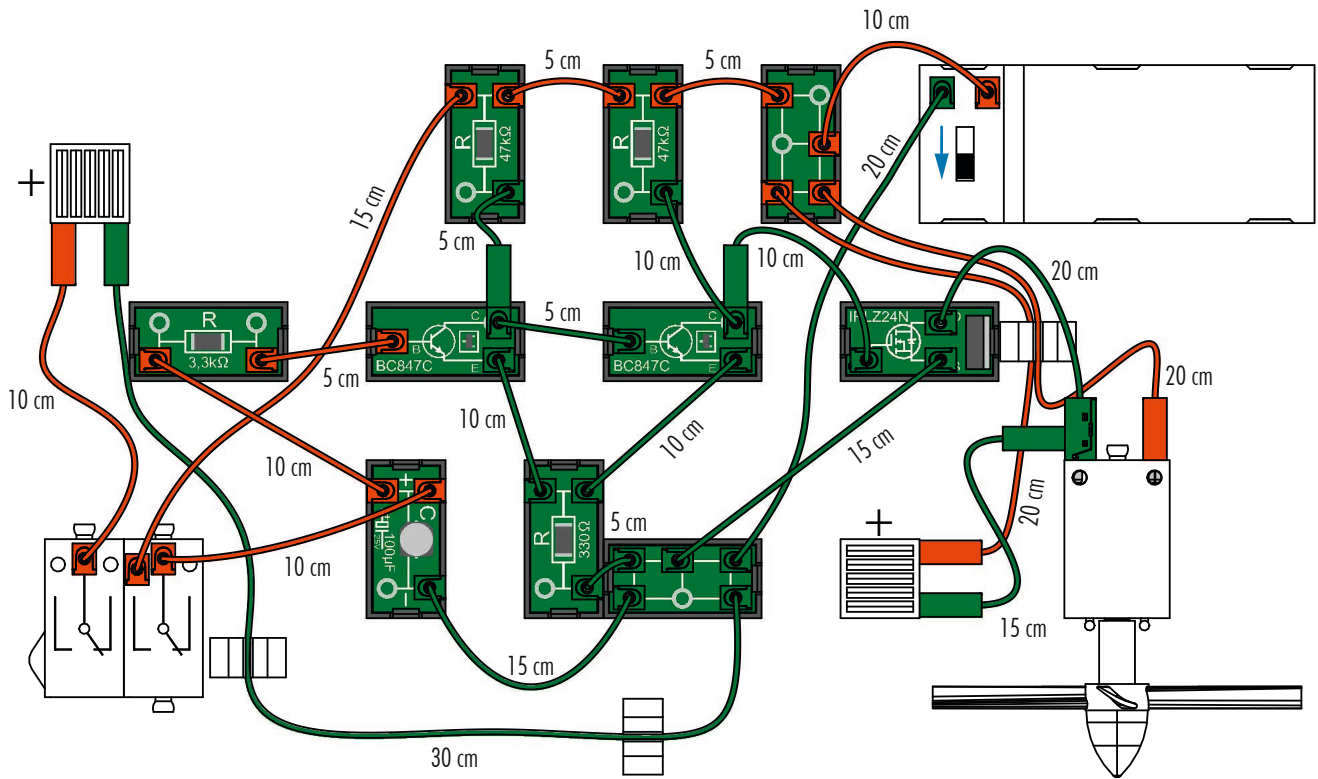

Schiebetür – Polwendeschaltung mit Dioden

Sliding door - pole-changing circuit with diodes

Porte coulissante - inverseur de pôles avec diodes

Schuijfeur - poolwisselschakeling met diodes

Puerta corredera - circuito de cambio de polos con diodos

Porta deslizando - circuito de mudança de pólo com diodos

Porta scorrevole - Circuito di inversione della polarità con diodi

Раздвижная дверь с диодным переключателем полярности

推拉门--带二极管的换极电路

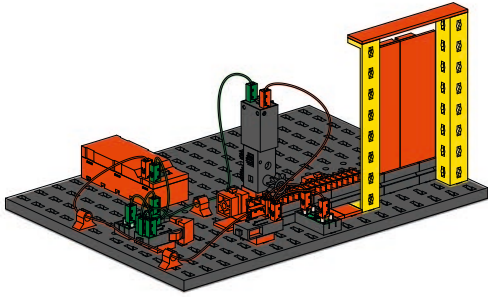

1

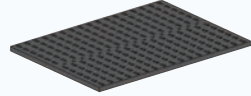

4 x



1 x

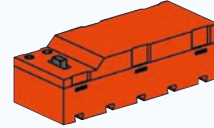

1 x

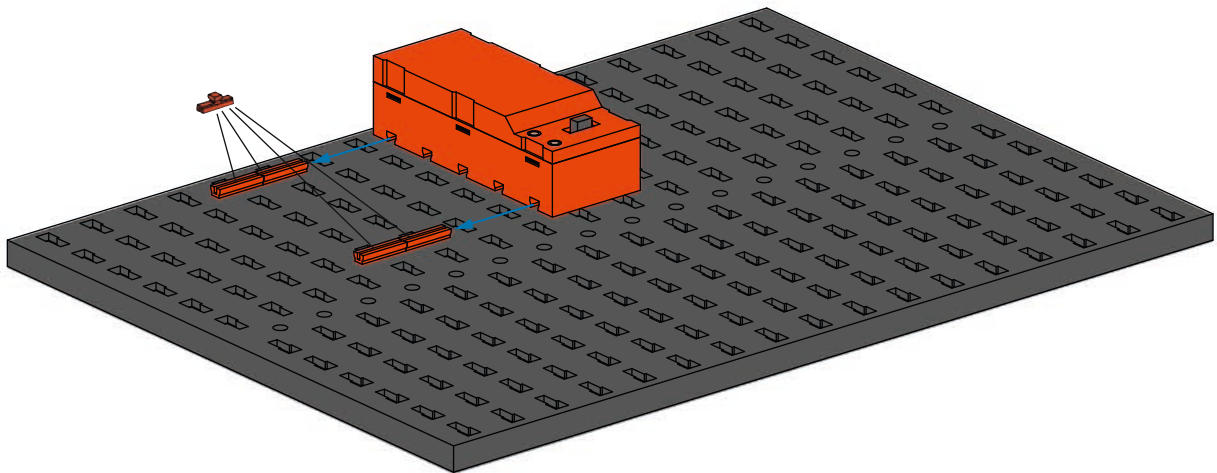

2



3 x



1 x



1 x

60°

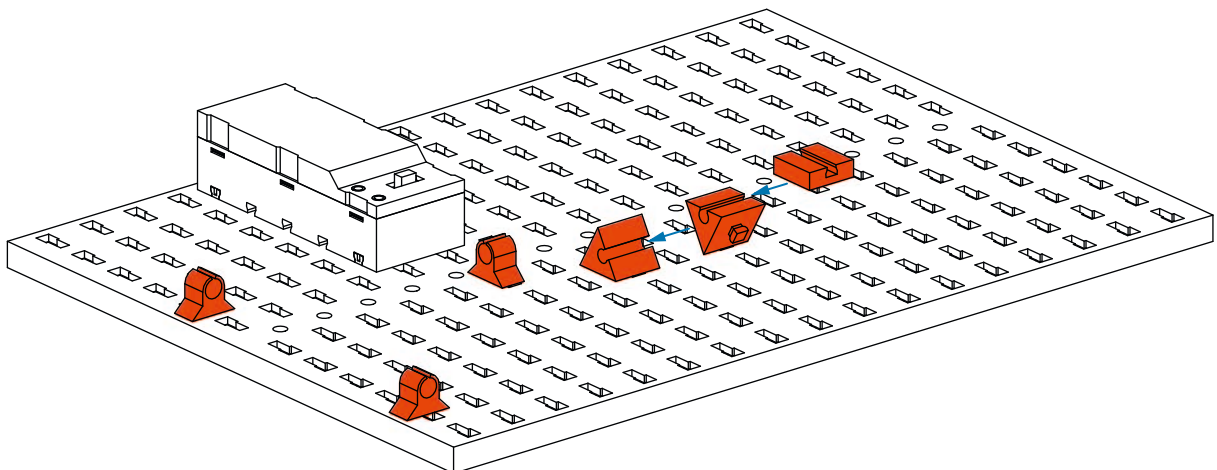
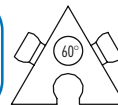

3



3 x



1 x

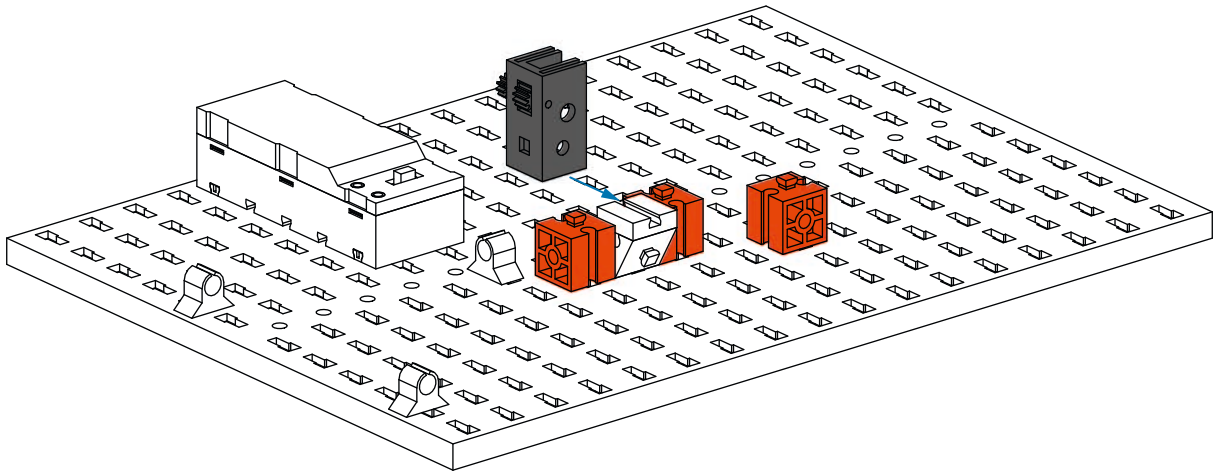

4

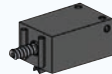

1 x



4 x

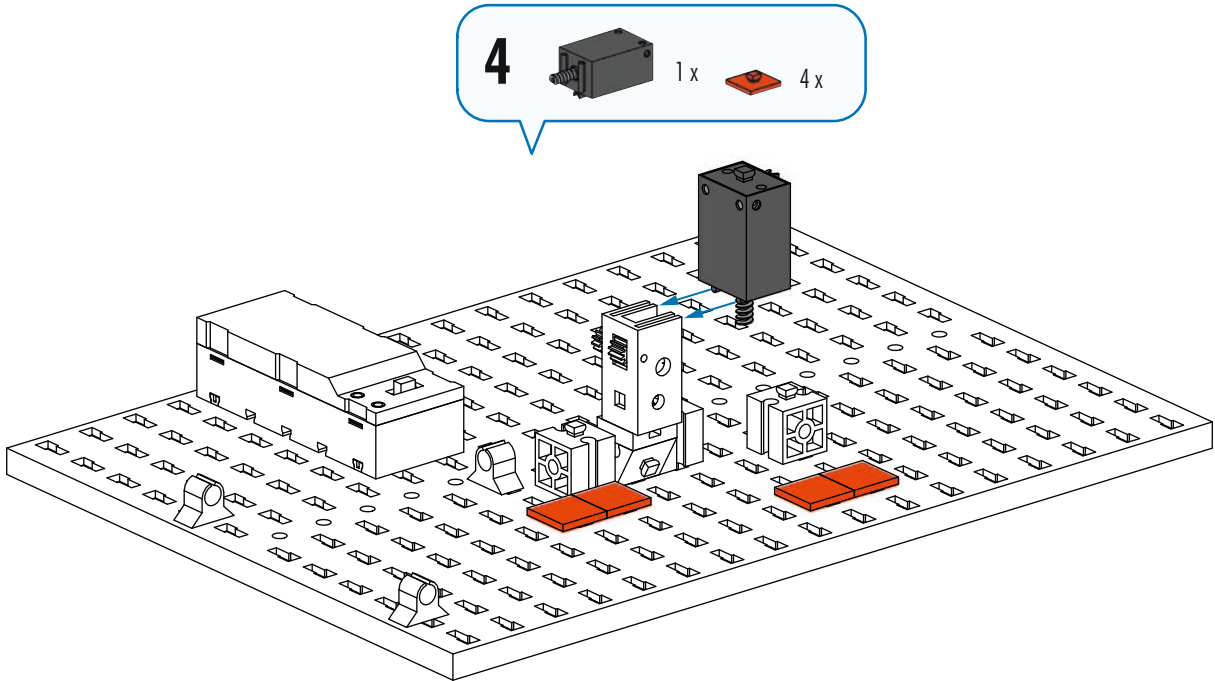

5

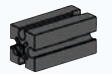

3 x



4 x

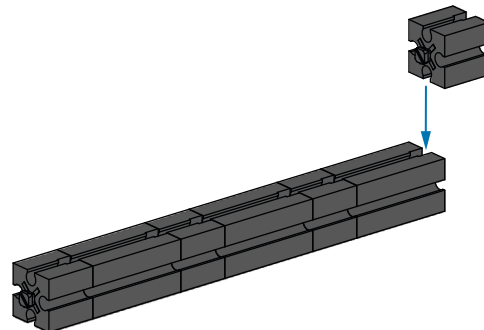

6

2x

2x

1x

1x

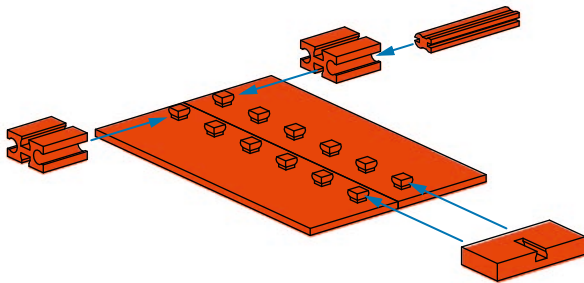
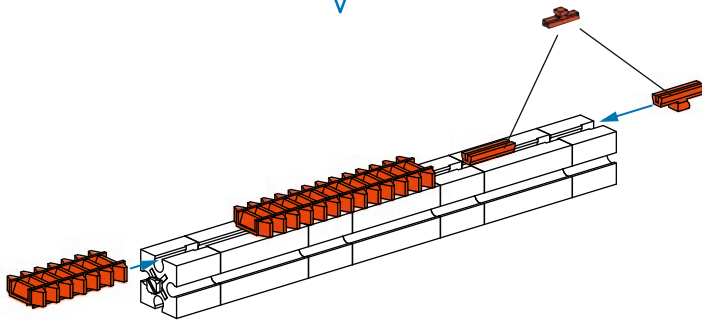

7

30 1x

2x

2x

1x

8

1x

1x

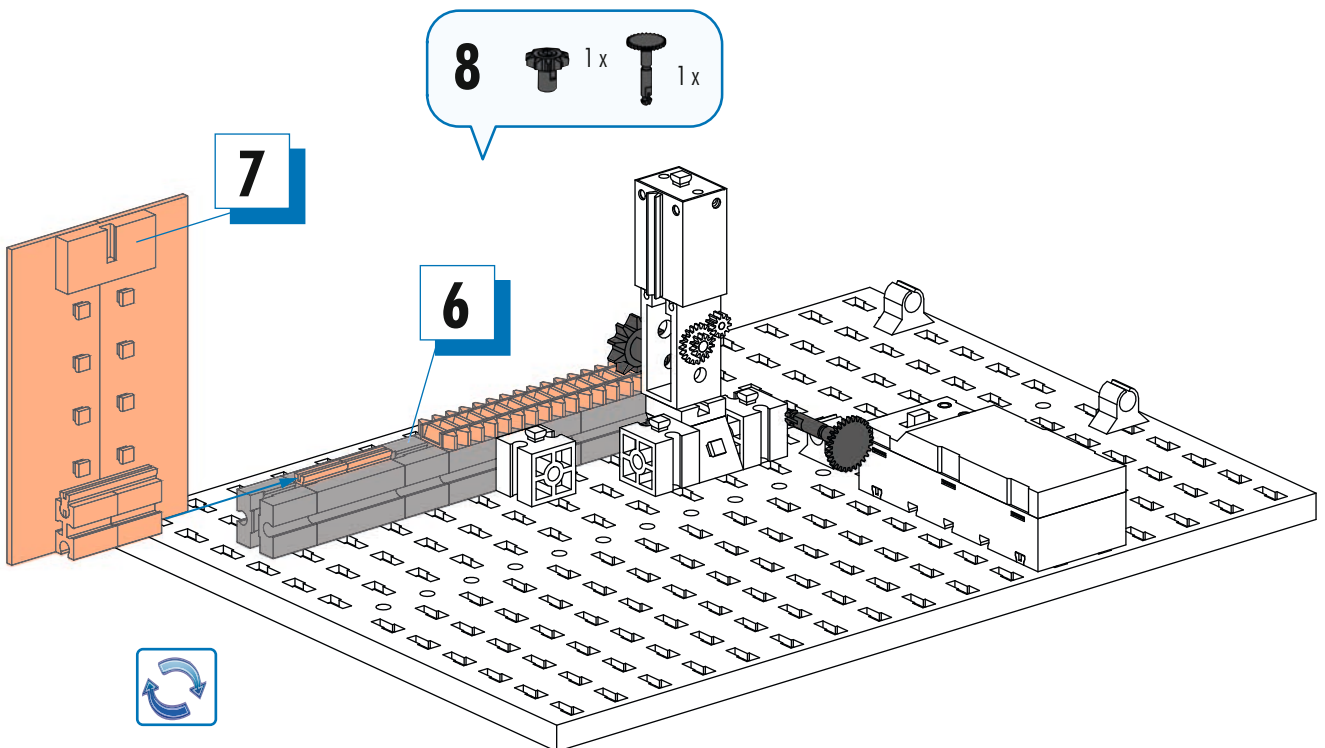

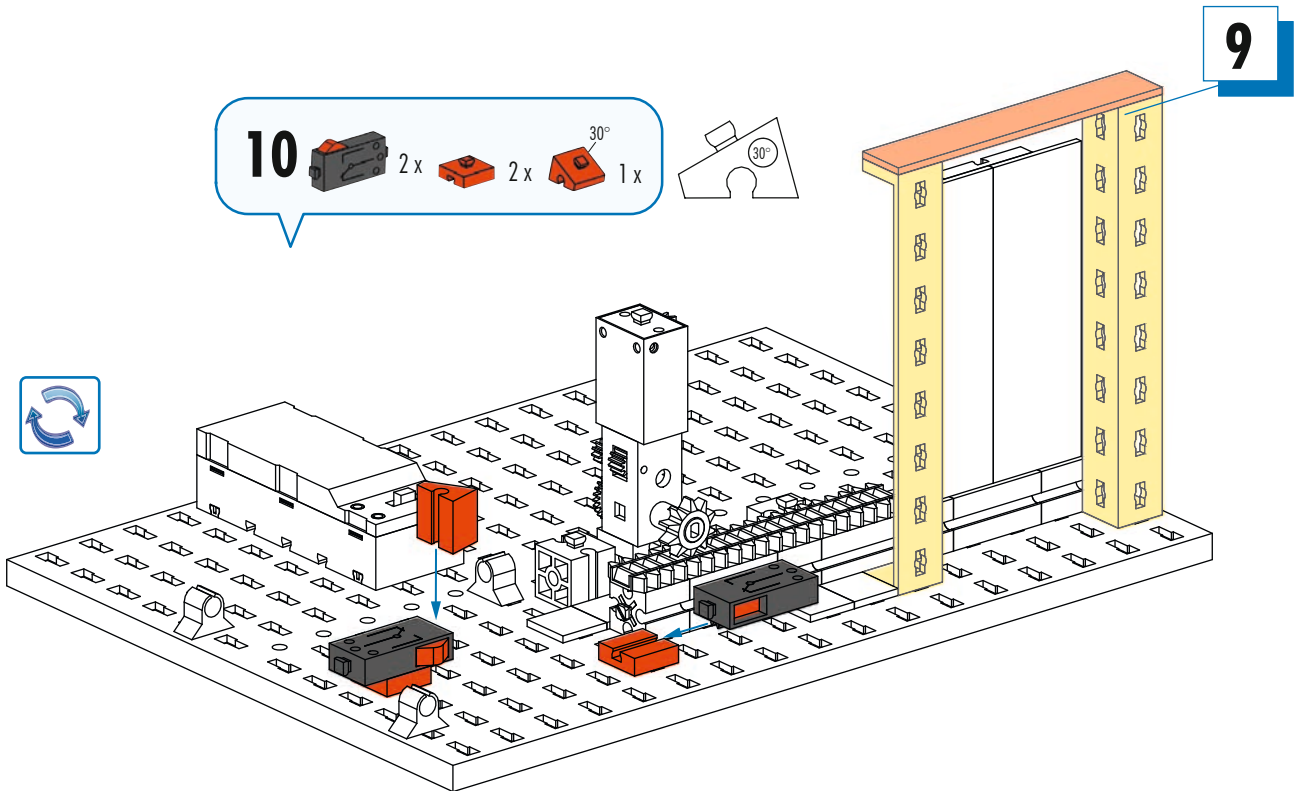
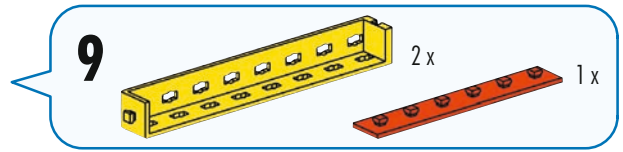
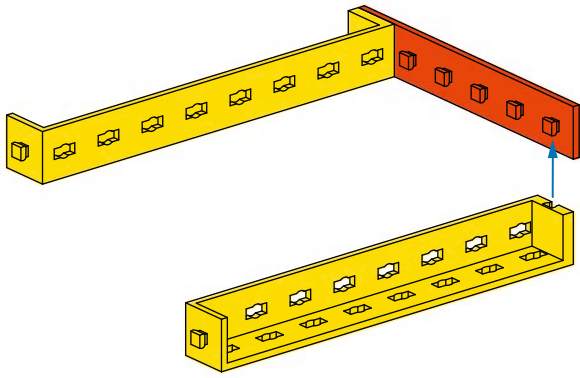

11  2 x
SID

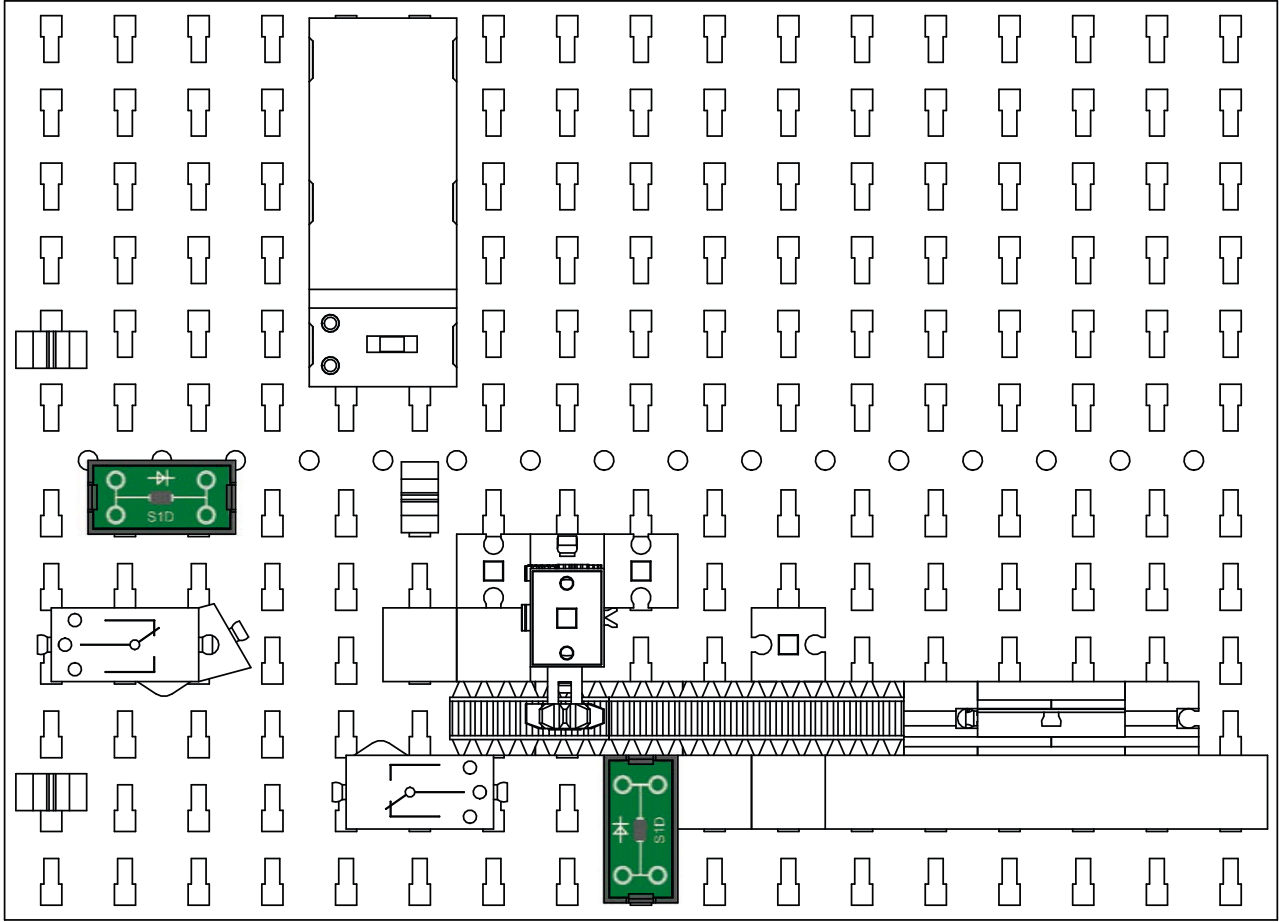

12  2 x - 10 cm
2 x - 20 cm

 2 x - 10 cm
1 x - 20 cm
1 x - 30 cm

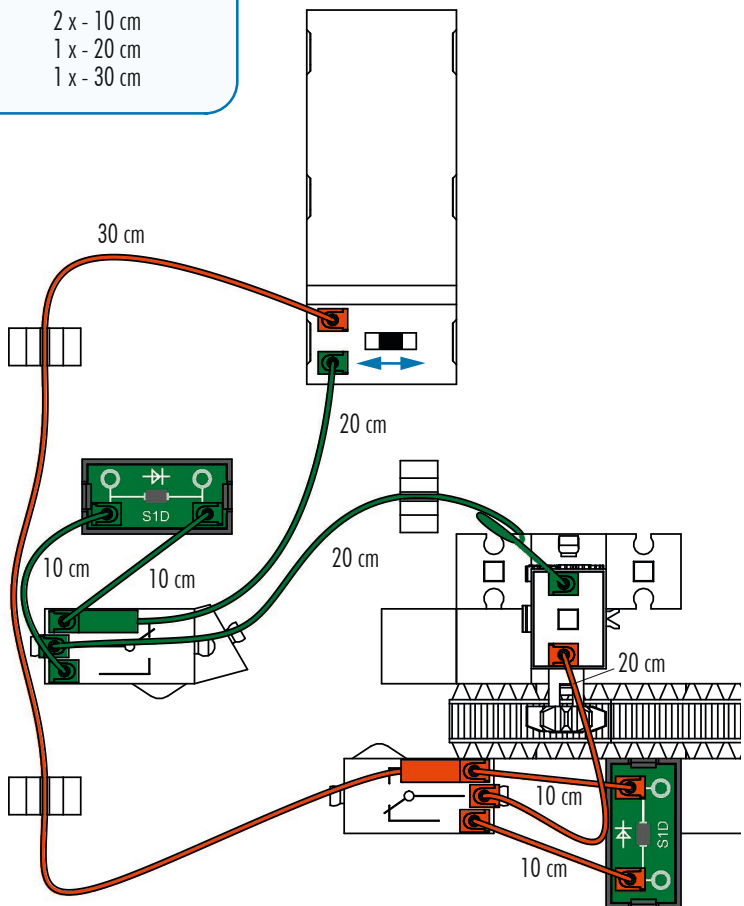

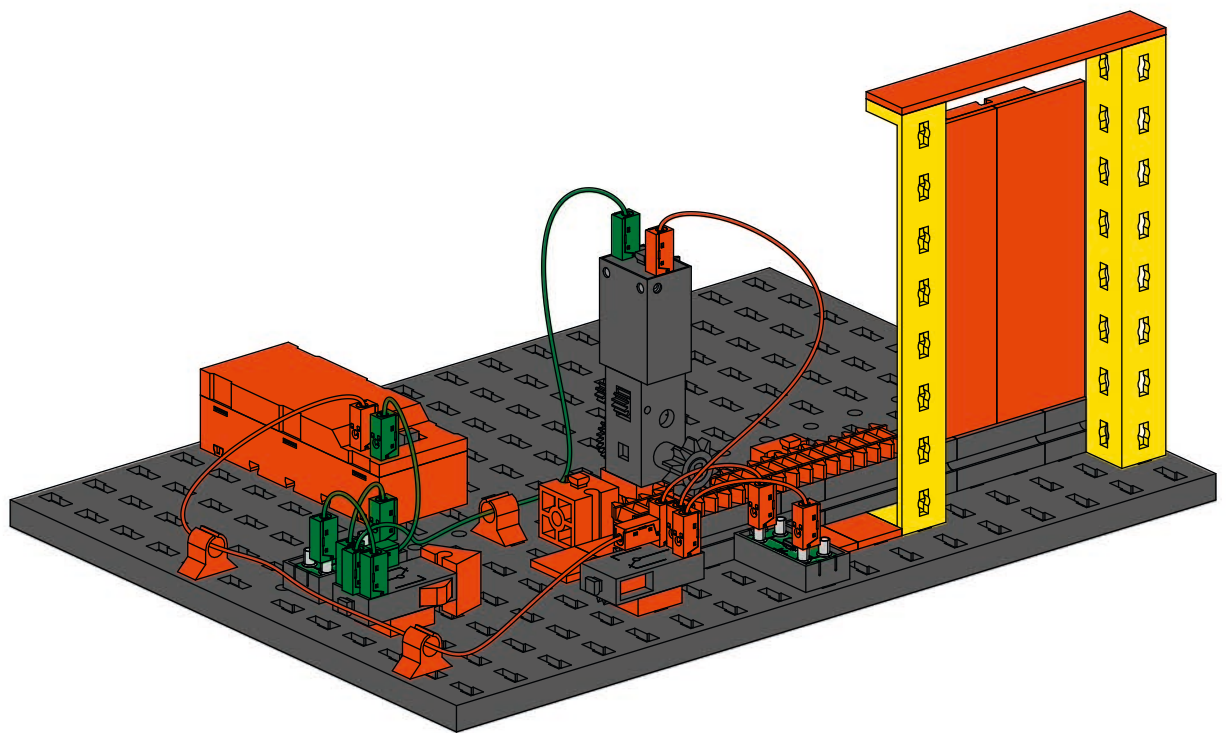





Gartenbewässerung
Garden irrigation
Arrosage du jardin

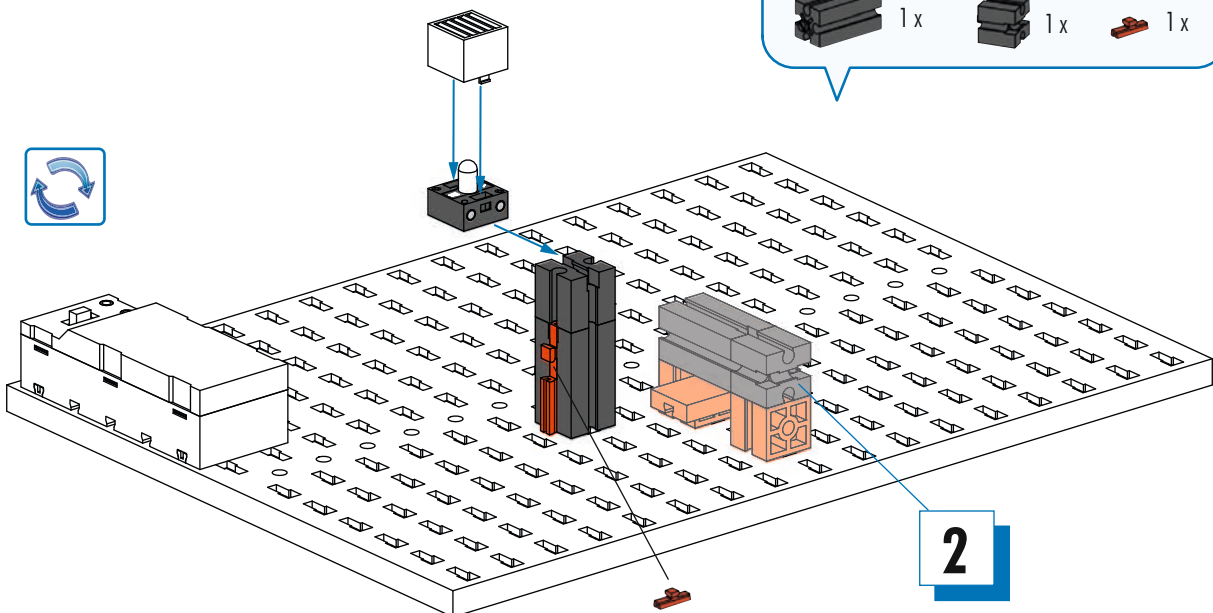
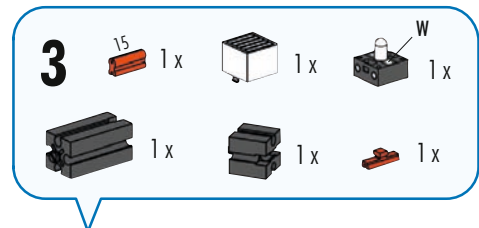
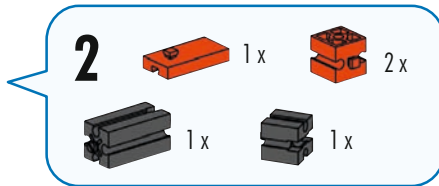
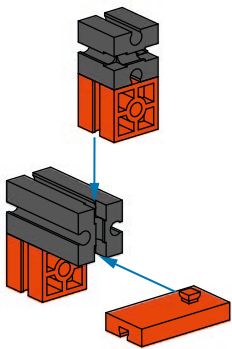
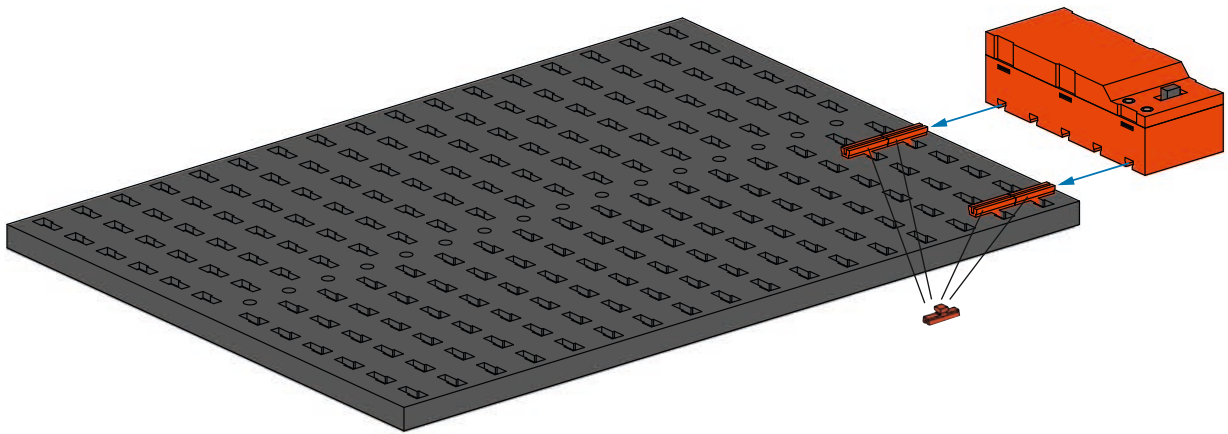
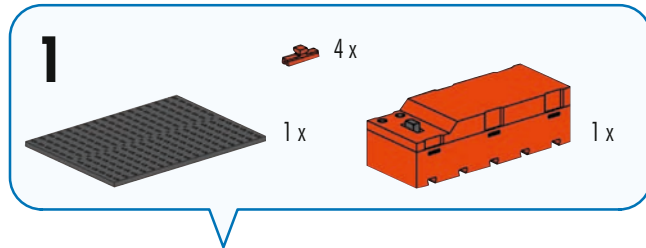
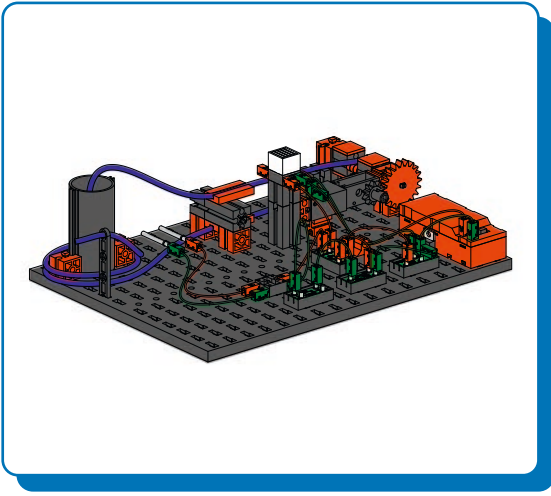

Tuin irrigatie
Riego de jardines
Irrigação de jardins



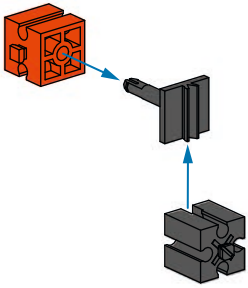
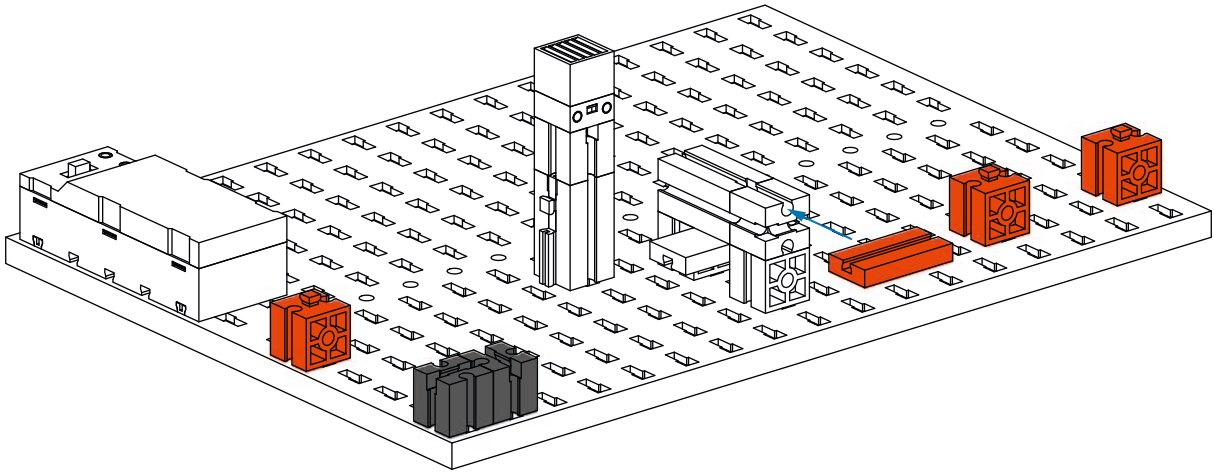

Irrigazione del giardino
Орошение сада
花园灌溉







4  1x  3x  2x

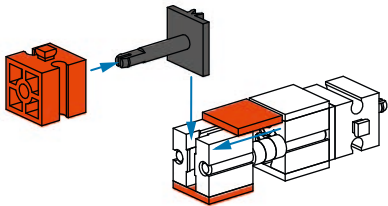
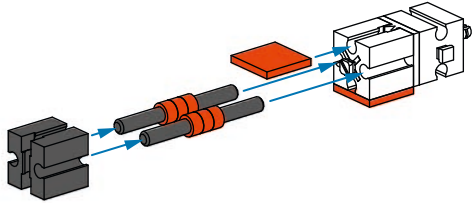

5  1x  1x  1x

6  1x  40 2x  2x  6x



7  2x  1x  1x

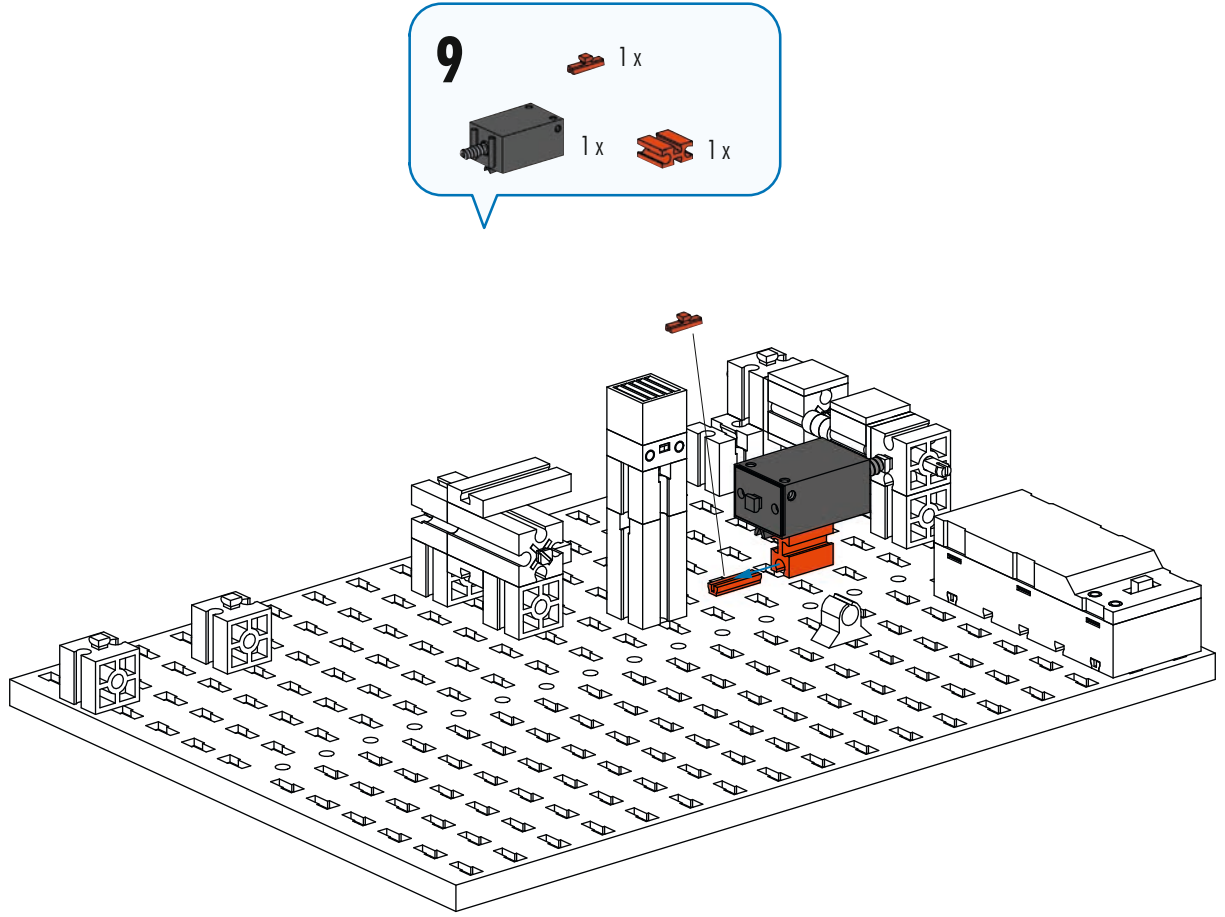
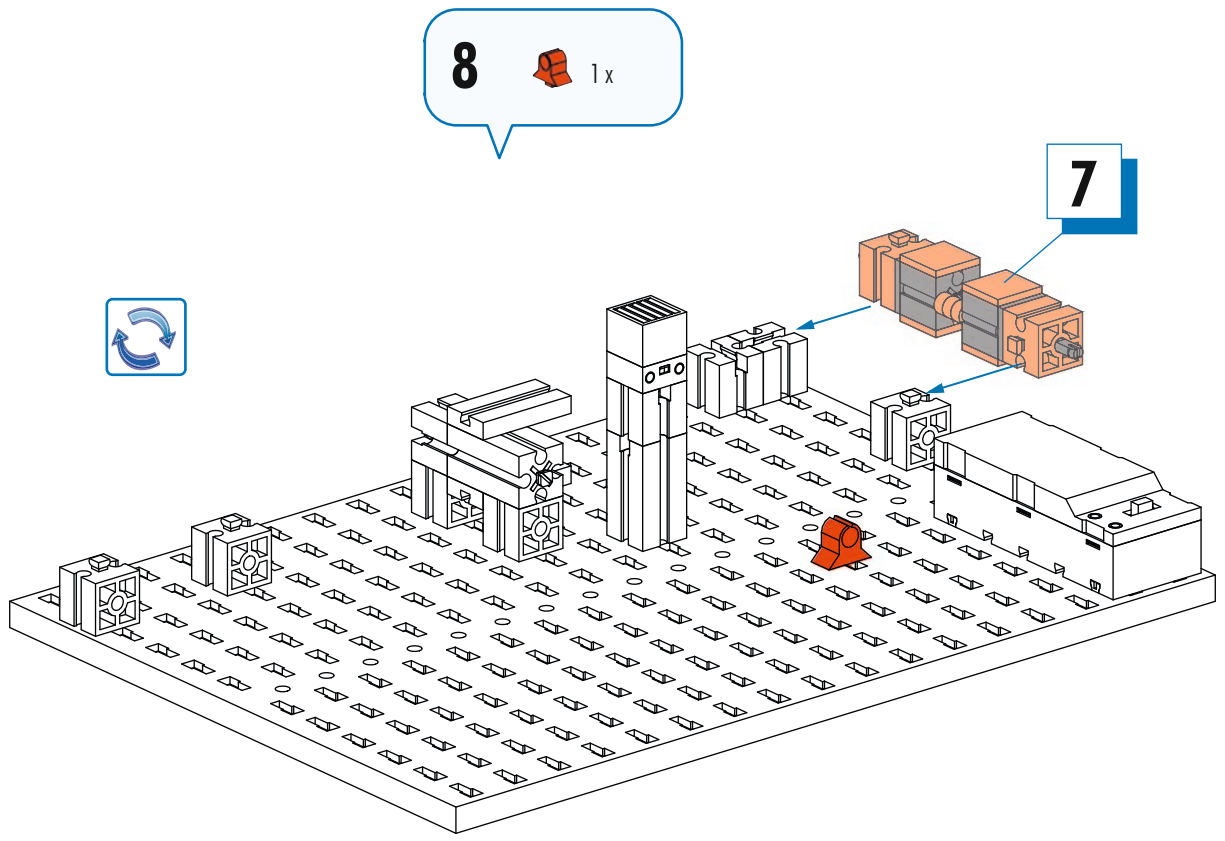

10

- 1x [Cylinder]
- 1x [Cap]
- 1x [Motor]
- 1x [Bracket]

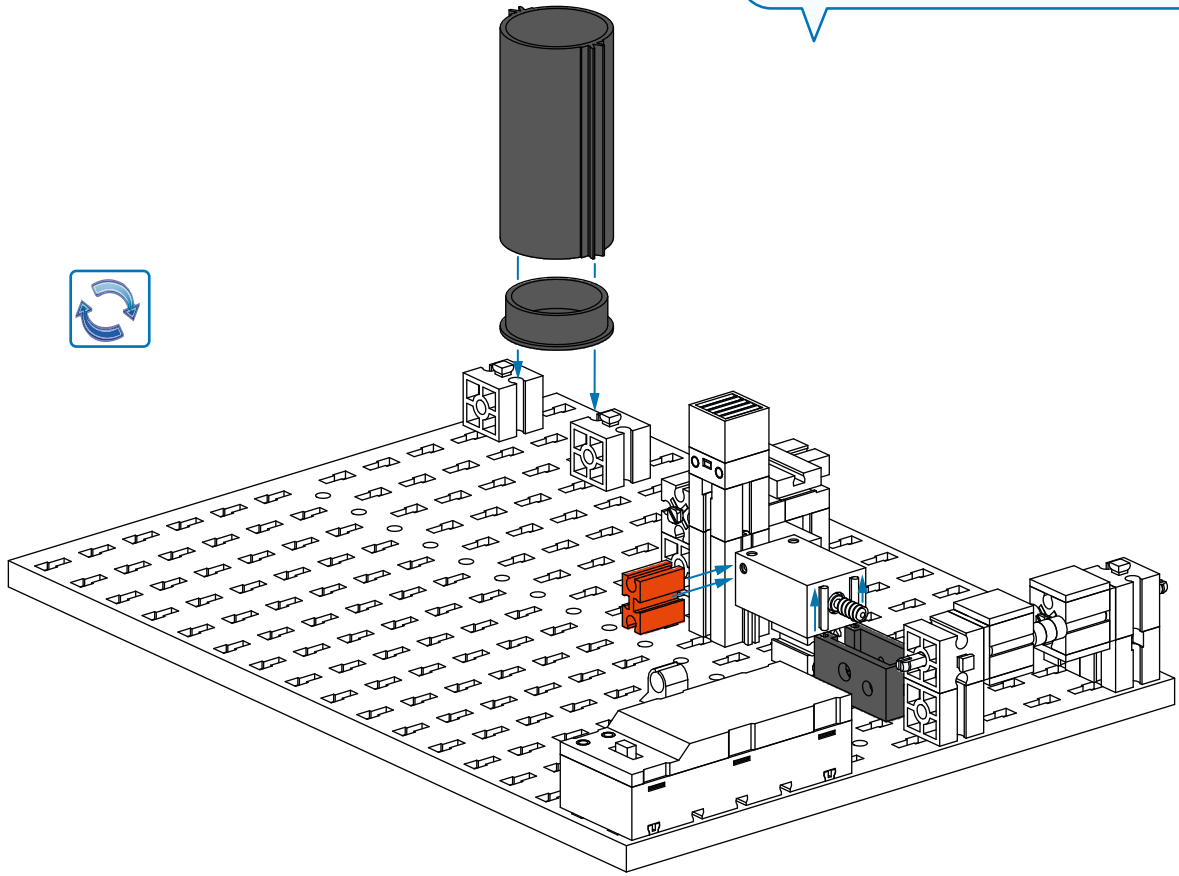

11

- 1x [30mm Beam]
- 1x [Bracket]
- 1x [Connector]

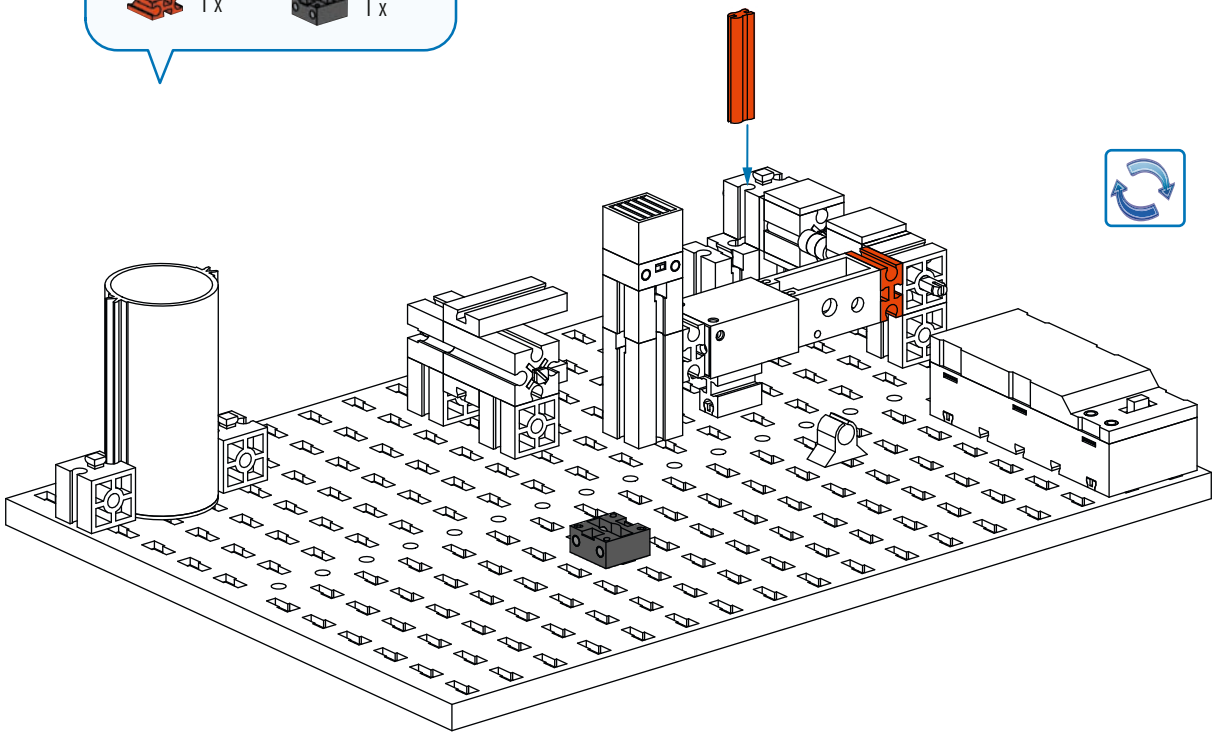

12

1x

1x

1x

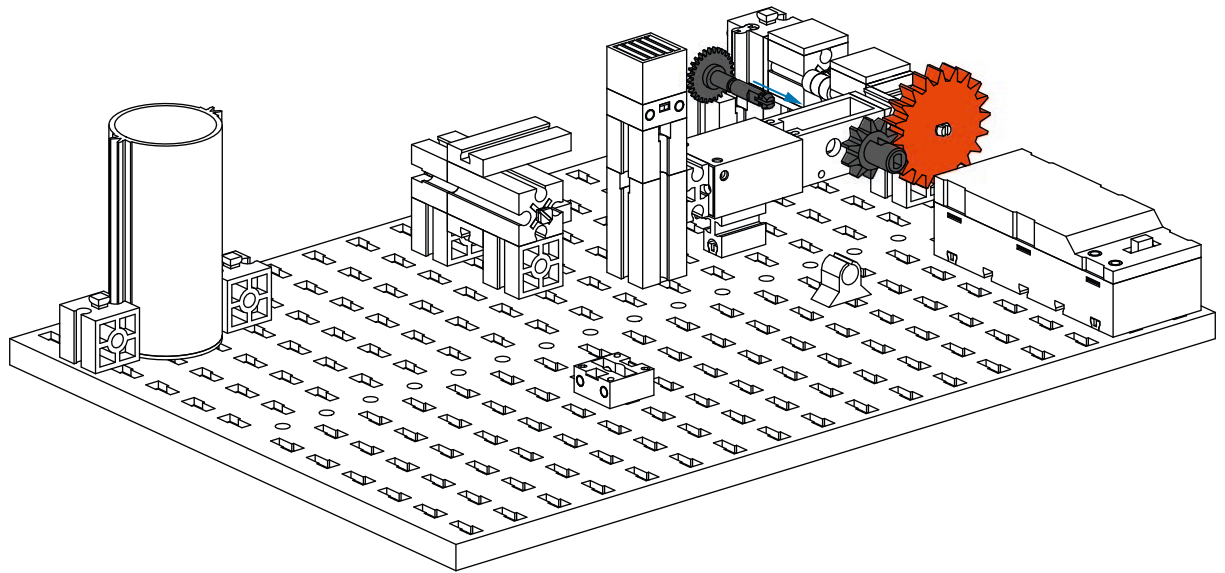

13

45 1x

1x

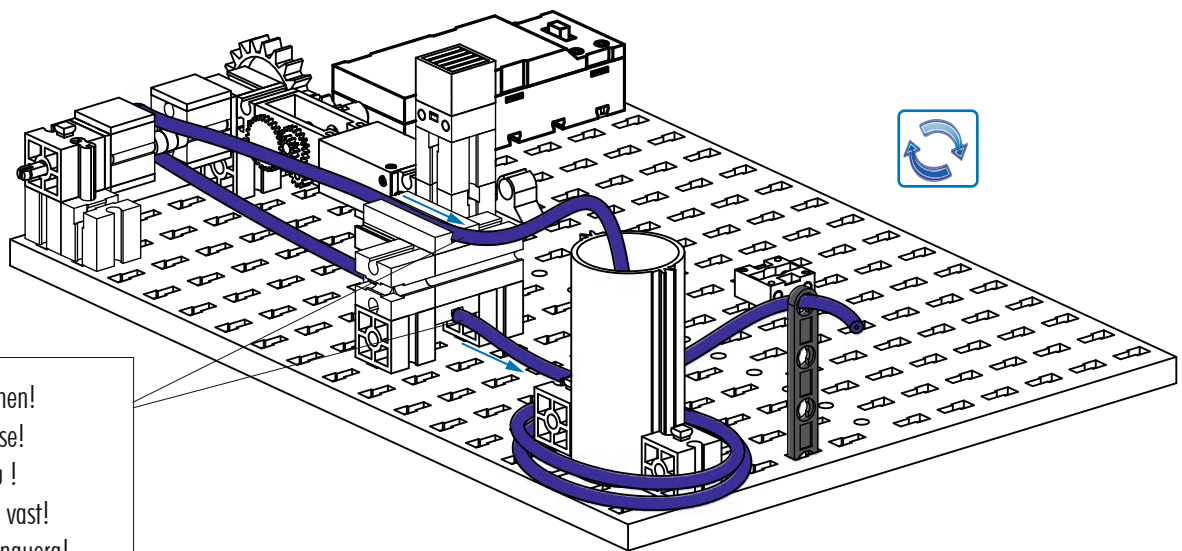

Schlauch spannen!
 Tighten the hose!
 Serrez le tuyau !
 Draai de slang vast!
 iAprieta la manguera!
 Aperte a mangueira!
 Stringere il tubo!
Затяните шланг!
 拧紧软管!

14

- 1 x BC847C
- 2 x 47 k Ω
- 1 x IRLZ24N

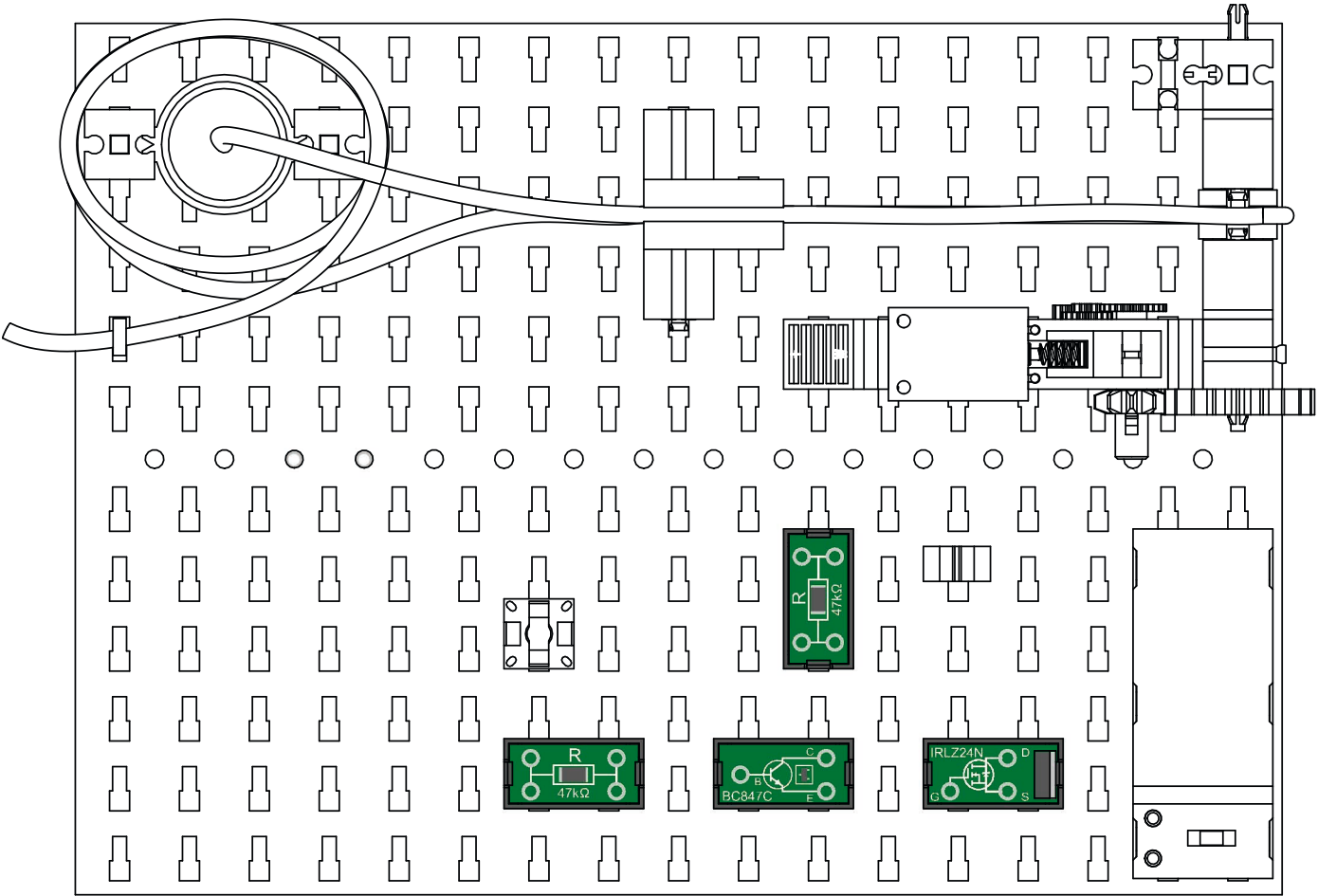

15

2 x - 5 cm
3 x - 10 cm
1 x - 20 cm
1 x - 30 cm

2 x - 5 cm
3 x - 10 cm
1 x - 20 cm
1 x - 30 cm

2 x

